

Power Choke

JSHC1040 Series

Automotive-Grade A0

JinLai's proven design and process support high reliability, high thermal characteristics, and high efficiency power chokes for automotive application.

DATA SHEET

Place of origin: Chongqing

目 录

1. Features	4
2. Application	4
3. Part No. Definition	4
4. Appearance and dimensions	4
5. Electrical Characteristics	5
6. Heat rating current VS saturation current curv	6
7. Packaging Specifications	8

5. Electrical Characteristics

Part Number	Inductance	Tolerance	RDC(m Ω)		Isat(A)		Irms(A)	
	(μ H)	(\pm %)	Typical	Max	Typical	Max	Typical	Max
JSHC1040H-2R2M-K-A5	2.2	20	8.0	8.9	20.0	18.0	12.3	11.1
JSHC1040H-3R3M-K-A5	3.3	20	10.6	11.8	17.5	15.8	11.0	9.9
JSHC1040H-4R7M-K-A5	4.7	20	15.8	17.6	13.5	12.2	9.0	8.1
JSHC1040H-6R8M-K-A5	6.8	20	22.5	25.0	12.0	10.8	8.0	7.2
JSHC1040H-8R2M-K-A5	8.2	20	26.1	29.0	9.6	8.6	7.8	7.0
JSHC1040H-100M-K-A5	10.0	20	28.8	32.0	8.5	7.5	6.8	6.1
JSHC1040H-150M-K-A5	15.0	20	43.2	48.0	7.0	6.3	5.5	5.0
JSHC1040H-220M-K-A5	22.0	20	58.0	66.0	6.0	5.4	4.6	4.1
JSHC1040H-330M-K-A5	33.0	20	86.0	94.5	5.5	5.0	4.2	3.8
JSHC1040H-470M-K-A5	47.0	20	125.0	145.0	4.2	3.8	3.5	3.2
JSHC1040H-680M-K-A5	68.0	20	184.5	205.0	3.5	3.2	2.0	1.8

Note: When ordering, please specify tolerance code. Tolerance: M= \pm 20%

- All data is tested on 25 $^{\circ}$ C ambient temperatures.
- Inductance is tested at 100kHz, 1.0V.
- Heat rating current: The value of DC current when product temperature rise is $\Delta T40^{\circ}$ C ($T_a=25^{\circ}$ C).
- Saturation current: The value of DC current when the inductance decreases approximately 30% of its.

Special remind: Circuit design, component placement, frequency, cooling system and etc.
all will affect the product temperature. Please verify the actual product temperature in the final application.

6.Heat rating current VS saturation current curv

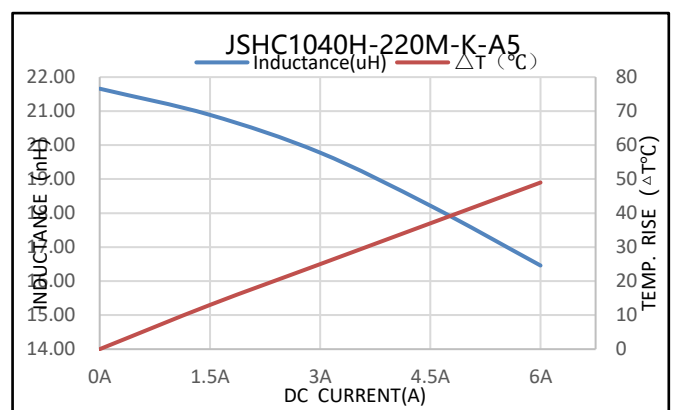
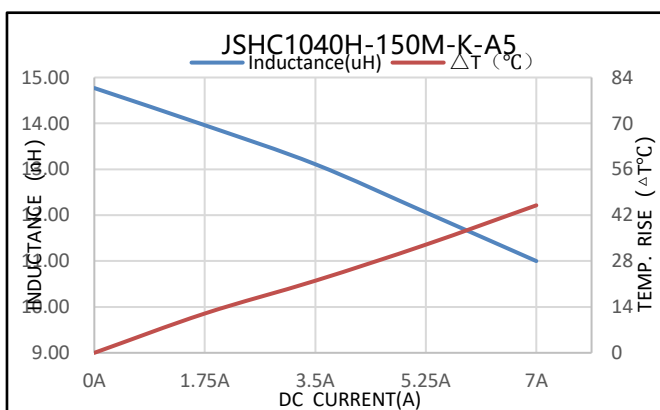
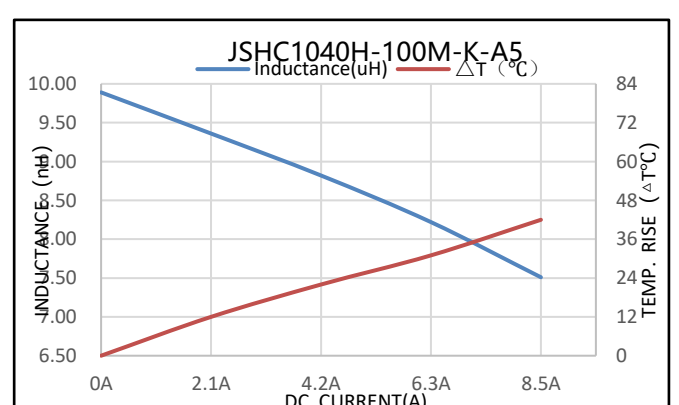
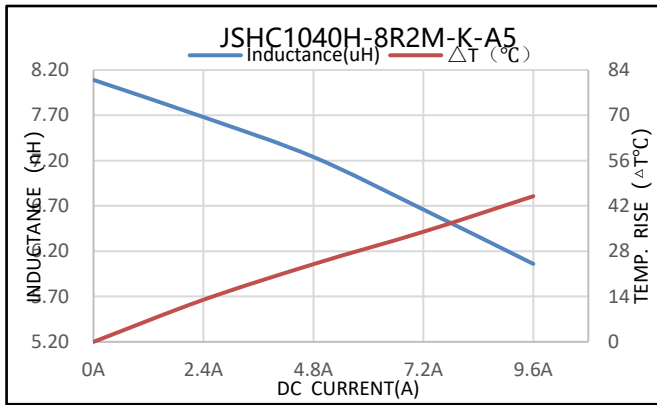
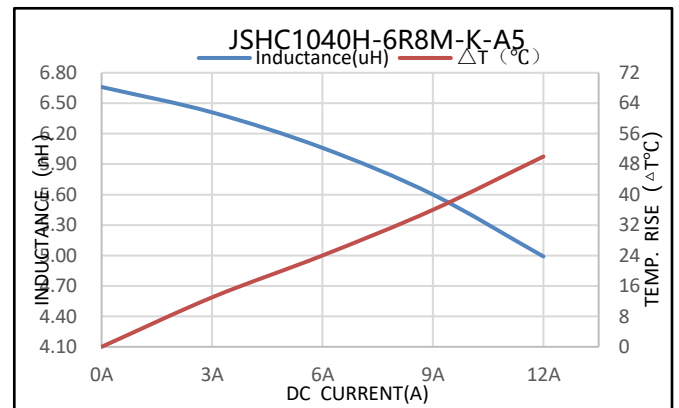
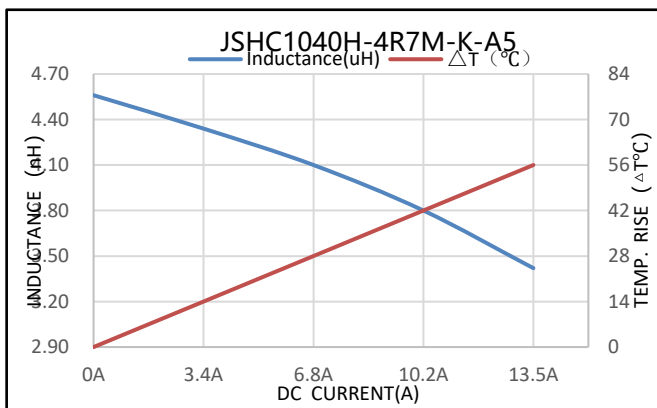
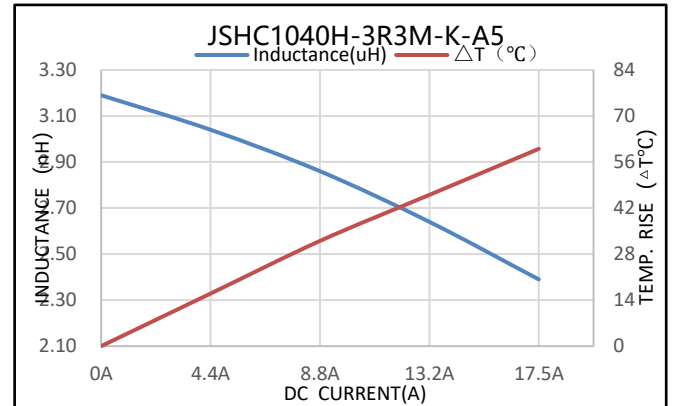
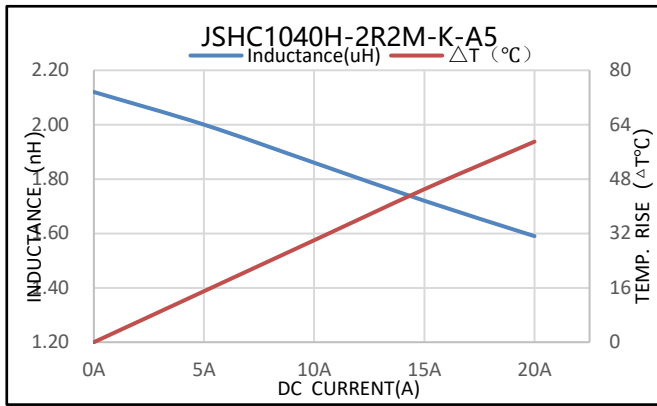

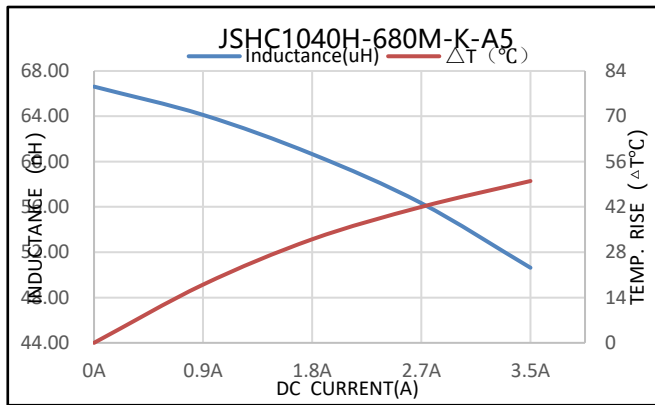
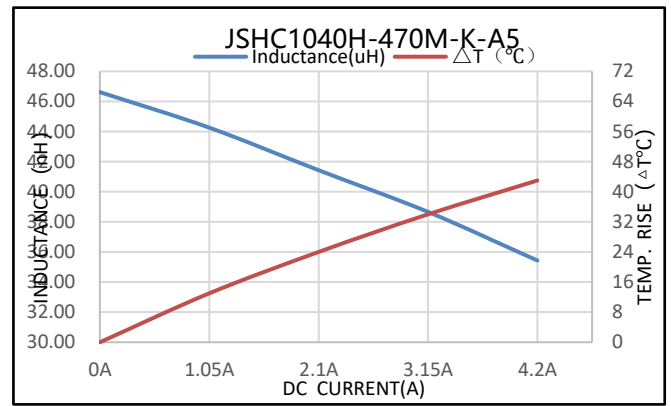
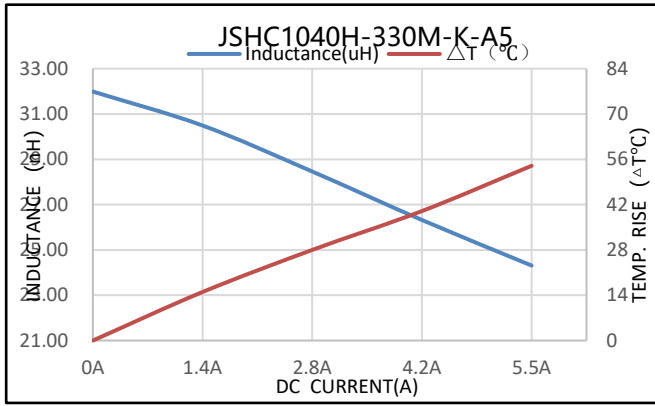

7.Packaging Specifications

Carrier tape dimensions

A0	10.6±0.2
B0	10.9±0.2
K0	4.3±0.15
W	24.0±0.3
P	16.0±0.1
F	11.5±0.1
T	0.40±0.05
D0	1.5±0.10

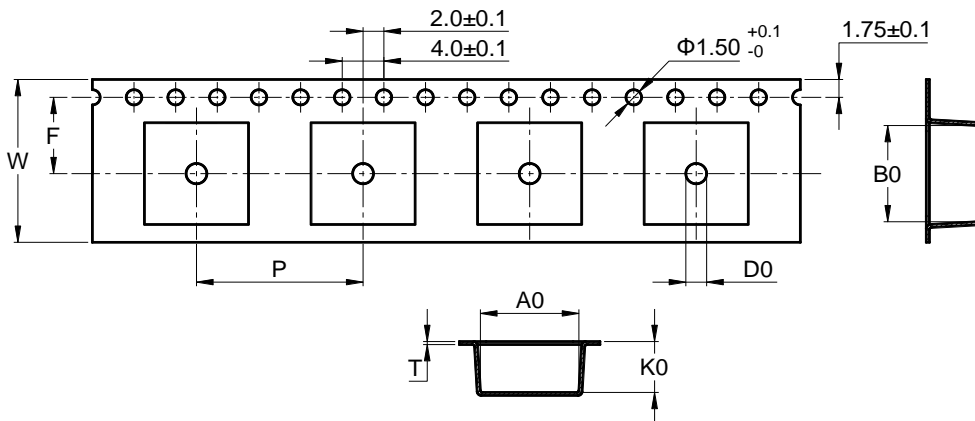

※ 包装参照国际标准 IEC 60286-3。
Packaging is referred to the international standard IEC 60286-3.

Packaging direction

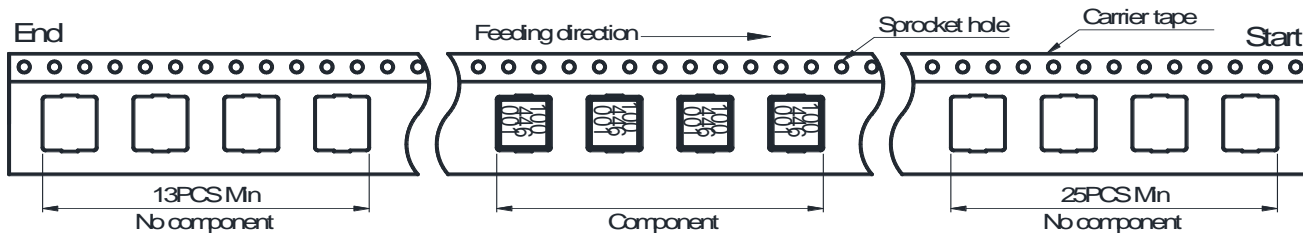

Reel dimensions

A	330 ± 2.0
B	100 Min
C	28.0Max
D	14.5 Min

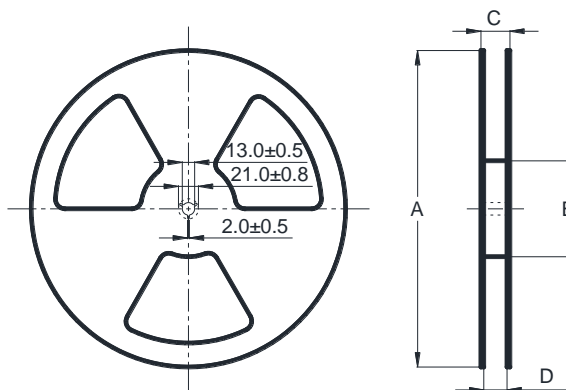

Cover tape peel-off condition

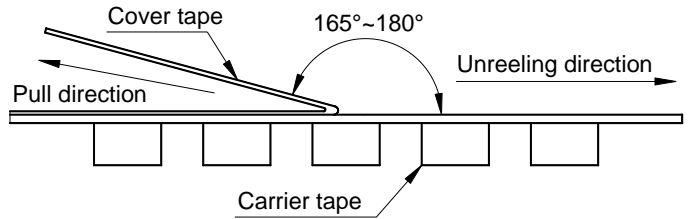
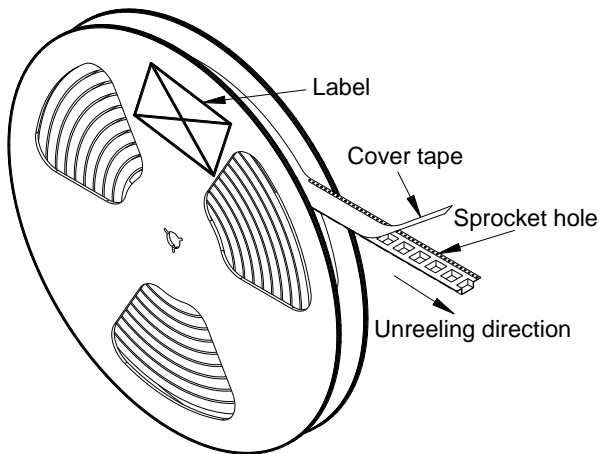

※ 盖带剥离力度为 0.1~1.3N。
Cover tape peel-off force will be 0.1 to 1.3N.
※ 参考剥离速度 300±10mm/分钟。
Reference peel-off speed 300±10mm/min.

Carton dimensions and packaging quantity

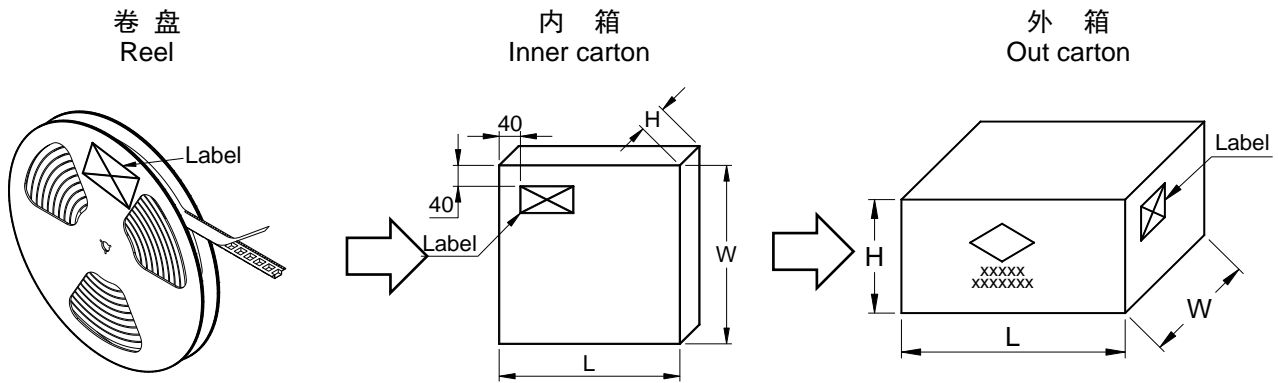

■ 内包装箱 (L×W×H) : 340×340×66mm
Inner Carton

■ 外包装箱 (L×W×H) : 360×360×215mm
Out Carton

SHC1040	每盘 包装数量 Per Reel Quatity	内箱 包装数量 Inner Carton Quatity	外箱 包装数量 Out Carton Quatity
	1,000 pcs	(1,000×2) = 2,000 pcs	(2,000×3) = 6,000 pcs

labeling requirement



图一

卷轴/啤盒/外箱标签（图一）

一、标签大小：70mm*50mm（横*竖）；

二、标签内容（图一）

- 1、MPN:实际金籁料号；
- 2、QTY：实际包装数量；
- 3、Lot No：生产批次，（如2446001，一个工单为一个批次，卷盘啤盒外箱同为一个批次，同周期不同工单批次叠加加流，每周从001开始）；
- 4、Supplier:JINLAI；
- 5、Customer:_____；
- 6、CPN:_____；
7. 条形码显示对应内容；
8. 二维码内容：MPN@QTY@Lot No

注：印字中的周期和流水需与出货标签Lot No中的周期和流水相对应，卷盘、啤盒、外箱共用以上标签模版，若遇多个批次产品合箱，啤盒、外箱都要对应显示Lot No，啤盒、外箱可同时贴多张标签体现。

三、标签粘贴位置

1. 卷轴标签粘贴位置如图所示（图二）
2. 啤盒的标签粘贴位置如（图三）
3. 外箱标签粘贴位置如图所示（图四）



图二



图三



图四