

Electrical Characteristics

Part Number	Inductance	Tolerance	Test Frequency	RDC	Isat	Irms
	(μH)	($\pm\%$)	(KHz)	($\text{m}\Omega$)Max	(mA) Typical	(mA)Typical
JSHC0420H-R22M-K	0.22	20	100	8	12.0	9.0
JSHC0420H-R33M-K	0.33	20	100	12	10.5	8.0
JSHC0420H-R47M-K	0.47	20	100	14	9.0	5.5
JSHC0420H-R56M-K	0.56	20	100	18	9.5	5.2
JSHC0420H-R68M-K	0.68	20	100	21	8.0	5.0
JSHC0420H-1R0M-K	1.0	20	100	27	7.0	4.5
JSHC0420H-1R5M-K	1.5	20	100	36	6.0	4.0
JSHC0420H-2R2M-K	2.2	20	100	58	5.0	3.0
JSHC0420H-3R3M-K	3.3	20	100	90	3.0	2.0
JSHC0420H-4R7M-K	4.7	20	100	150	3.0	2.0
JSHC0420H-5R6M-K	5.6	20	100	160	2.6	2.0
JSHC0420H-6R8M-K	6.8	20	100	170	2.5	2.0
JSHC0420H-100M-K	10.0	20	100	200	2.0	1.5

Note: When ordering, please specify tolerance code. Tolerance: M= $\pm 20\%$

- All data is tested on 25°C ambient temperature.
- Inductance is tested at 100kHz, 1.0V.
- Heat rating current: The value of DC current when product temperature rise is $\Delta T 40^\circ\text{C}$ ($T_a=25^\circ\text{C}$).
- Saturation current: The value of DC current when the inductance decreases approximately 30% of its.

Special remind: Circuit design, component placement, frequency, cooling system and etc. all will affect the product temperature. Please verify the actual product temperature in the final application.

Heat rating current VS saturation current curv

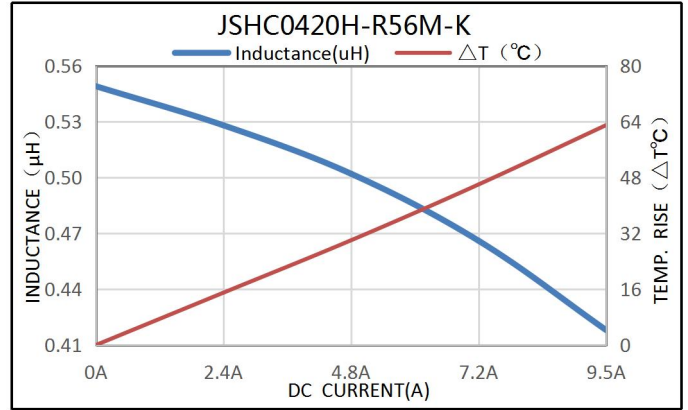
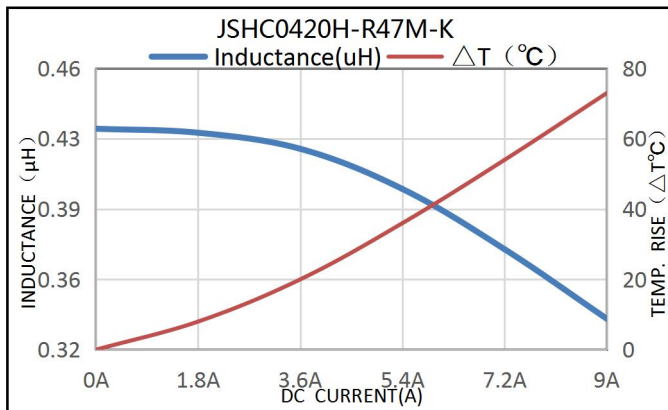
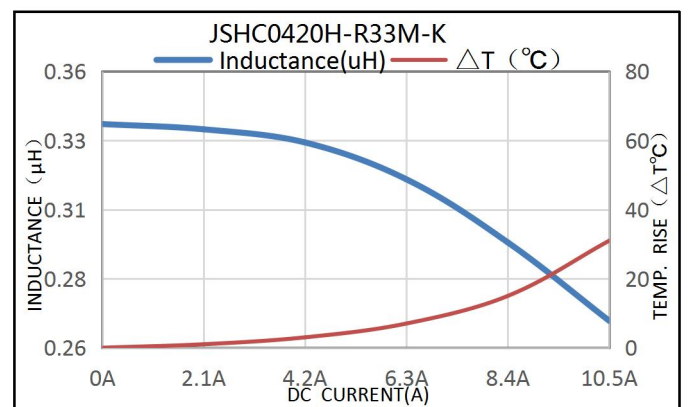
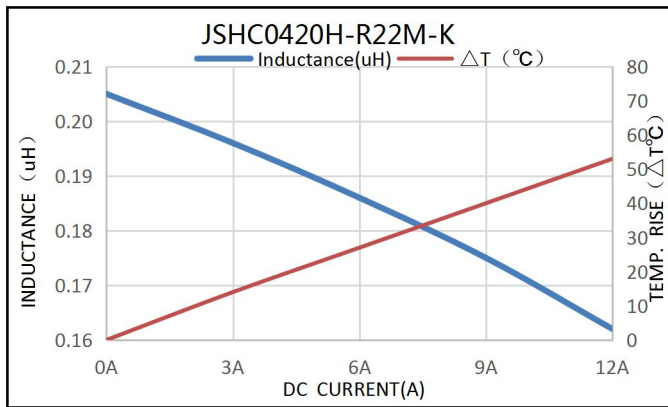

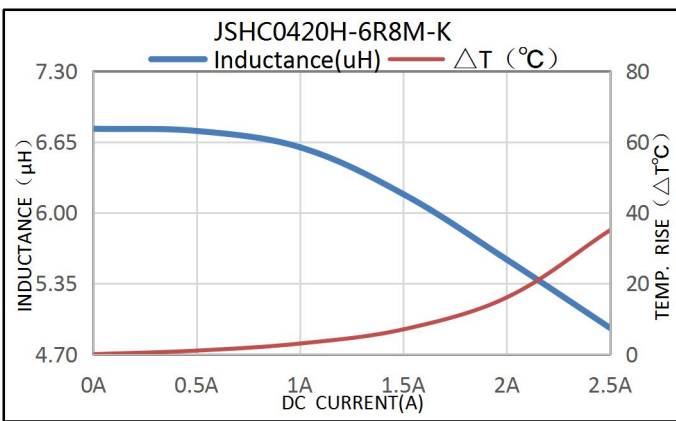
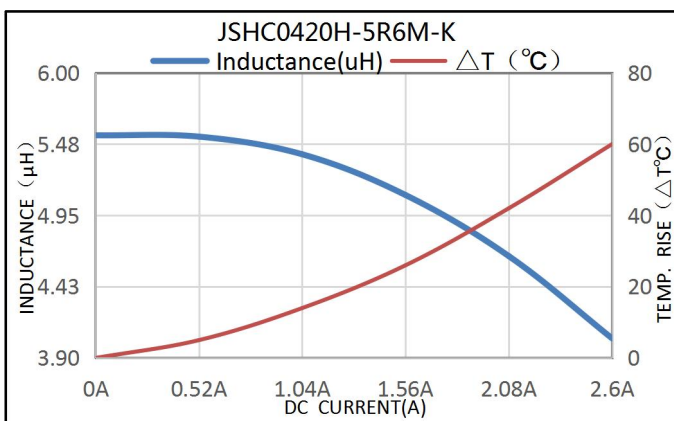
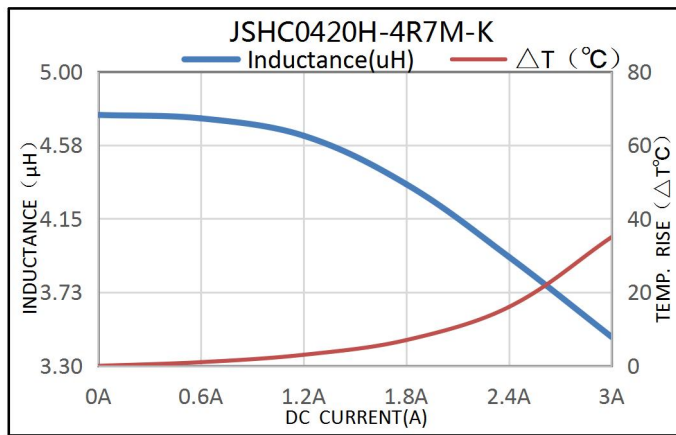
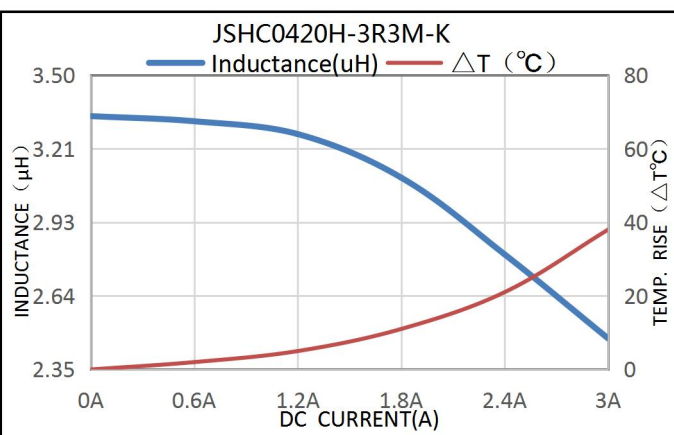
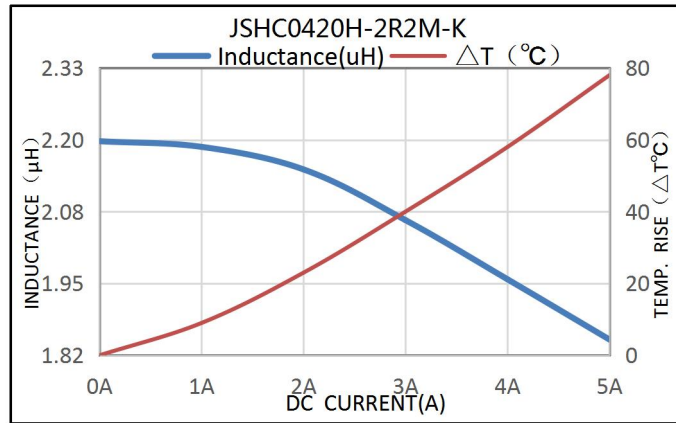
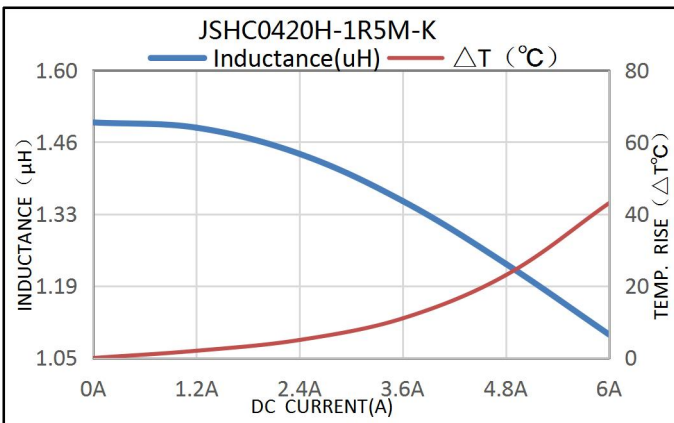
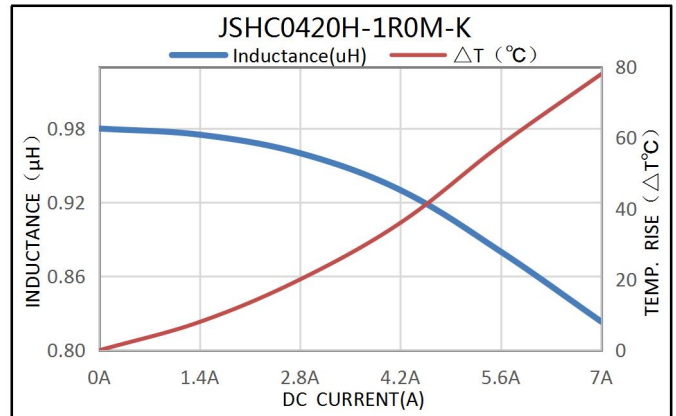
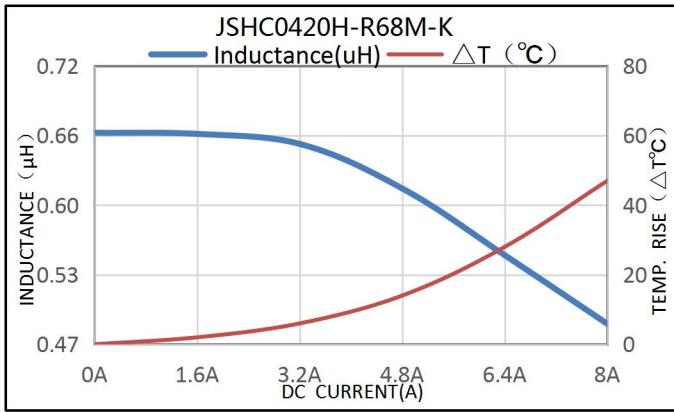

Packaging Specifications

Carrier tape dimensions

A0	4.35±0.2
B0	4.9±0.2
K0	2.25±0.1
W	12.0±0.3
P	8.0±0.2
F	5.50±0.1
T	0.35±0.05
D0	1.5±0.10

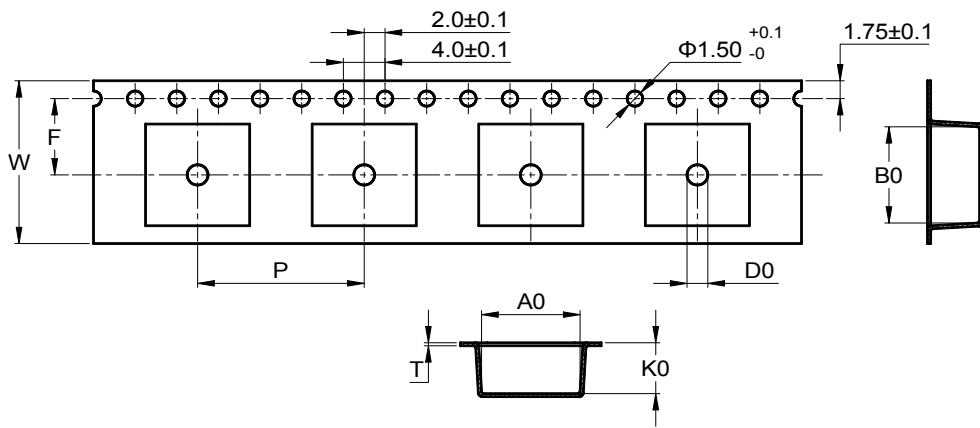

※ 包装参照国际标准 IEC 60286-3。

Packaging is referred to the international standard IEC 60286-3.

Packaging direction

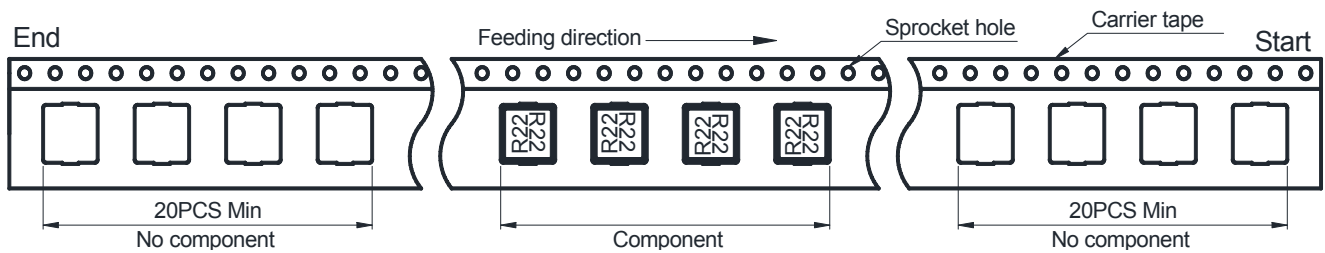

Reel dimensions

A	330 ± 2.0
B	100 Min
C	20.0Max
D	12.5 Min

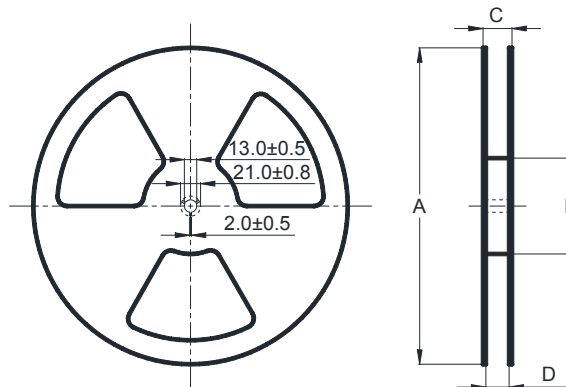

Cover tape peel-off condition

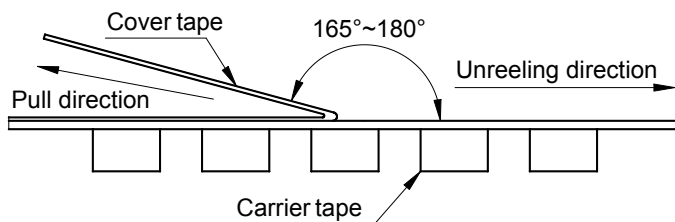
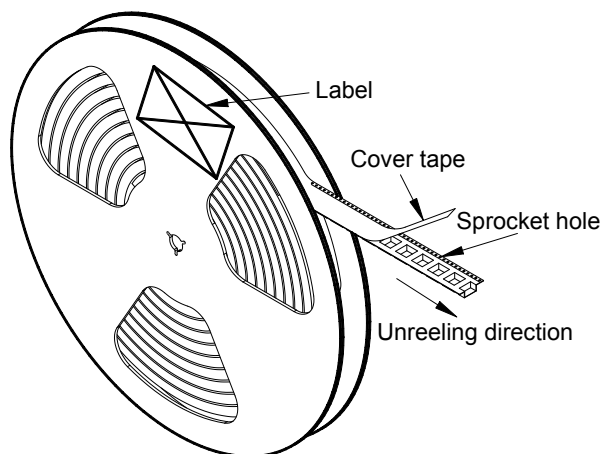

※ 盖带剥离力度为 0.1~1.3N.

Cover tape peel-off force will be 0.1 to 1.3N.

※ 参考剥离速度 300±10mm/分钟。

Reference peel-off speed 300±10mm/min.

Carton dimensions and packaging quantity

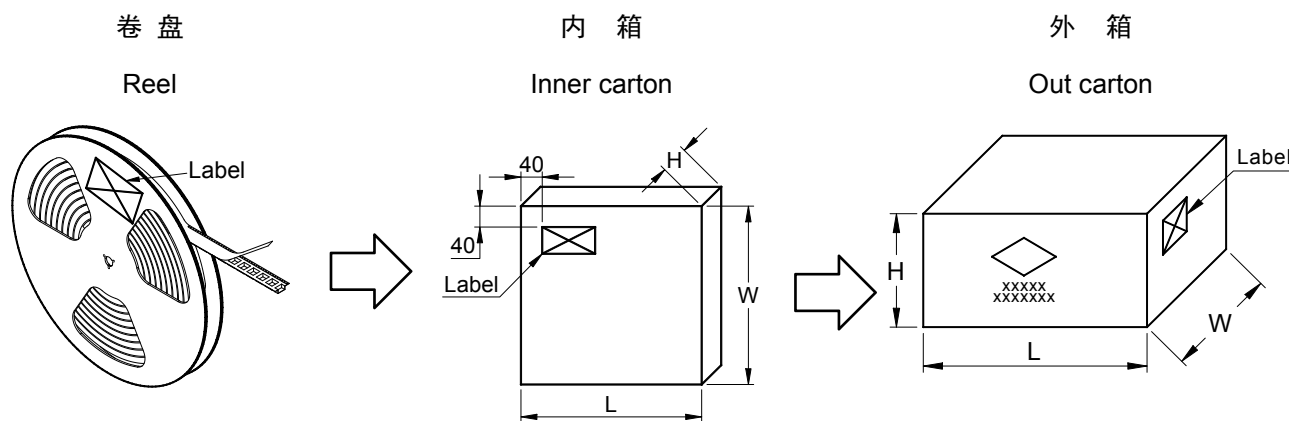

■ 内装箱(L×W×H): 340×340×52mm
Inner Carton

■ 外包装箱(L×W×H): 354×354×176mm
Out Carton

SHC0420	每盘 包装数量 Per Reel Quatity	内箱 包装数量 Inner Carton Quatity	外箱 包装数量 Out Carton Quatity
	3,000 pcs	(3,000×2) = 6,000 pcs	(6,000×3) = 18,000 pcs