

Molding Power Choke



Integrated forming inductor independent mold opening, with a number of design patents, a number of independent knowledge products; Small volume, small current, can maintain good temperature rise current and saturation current characteristics at high temperature; Adopt one body forming structure, strong, magnetic circuit closed, with good magnetic shielding and EMI performance; Magnetic shield structure, magnetic circuit closed, strong anti-electromagnetic interference, with very low buzzer, high installation density; Low loss alloy powder die-casting, low impedance; High precision, durable rust prevention;

Features

- Products are lead-free, in line with RoHS directive, Halogen Free and REACH Compliance
- SMD surface mount inductor
- The integrated structure avoids noise
- Lowest DC impedance of the same size
- The current resistance inductance value drops to ensure smooth
- Up to 5MHz application frequency
- Fully enclosed magnetic shielding structure can effectively reduce electromagnetic interference

Applications

- DC-DC converters
- Power modules
- CONSUME
- Laptop, MOTHERBOARD, INDUSTRY
- Communication networks, Internet of Things and other electronic devices

Product Identification

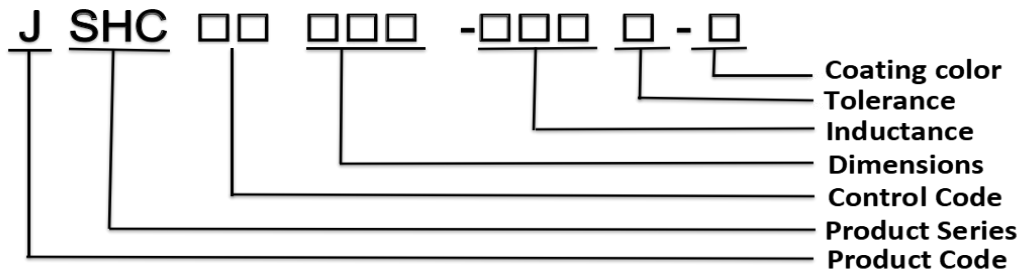

Appearance and dimensions

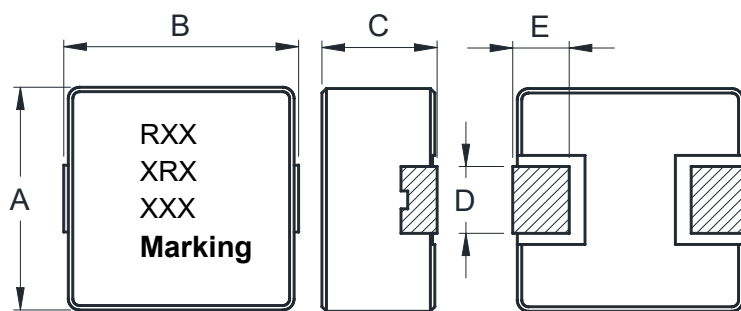

Reference PCB pattern

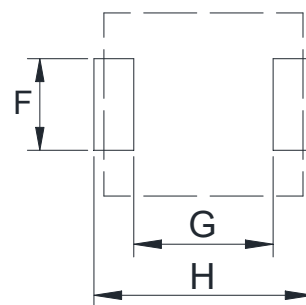

Schematic

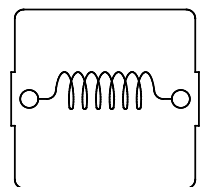

Dimensions in mm

A	B	C	D	E	F	G	H
10.6Max	11.6Max	4.0Max	3.0±0.5	2.0±0.5	4.8Ref	5.0Ref	12.0Ref

重庆金籁科技股份有限公司

Electrical Characteristics

Part Number	Inductance	Tolerance	Test Frequency	RDC(m Ω)	Isat(A)	Irms(A)
	(μ H)	(\pm %)	(KHz)	Max(Typical)	Typical(Max)	Typical(Max)
JSHC1040H-R22M-K	0.22	20	100	1(0.9)	60.0(54)	35.0(31.5)
JSHC1040H-R68M-K	0.68	20	100	3(2.7)	31.0(27.9)	23.0(20.7)
JSHC1040H-1R0M-K	1.0	20	100	4.1(3.69)	28.0(25.2)	18.0(16.2)
JSHC1040H-2R2M-K	2.2	20	100	9(8.1)	20.0(18)	12.0(10.8)
JSHC1040H-3R3M-K	3.3	20	100	13.5(12.15)	16.0(14.4)	10.0(9)
JSHC1040H-4R7M-K	4.7	20	100	16.5(14.85)	13.0(11.7)	9.5(8.55)
JSHC1040H-6R8M-K	6.8	20	100	30(27)	12.0(10.8)	8.0(7.2)
JSHC1040H-220M-K	22	20	100	66(59.4)	6.0(5.4)	3.5(3.15)

Note: When ordering, please specify tolerance code. Tolerance: M=±20%

- All data is tested on 25°C ambient temperature.
- Inductance is tested at 100kHz, 1.0V.
- Heat rating current: The value of DC current when product temperature rise is $\Delta T40^{\circ}\text{C}$ ($T_a=25^{\circ}\text{C}$).
- Saturation current: The value of DC current when the inductance decreases approximately 30% of its.

Special remind: Circuit design, component placement, frequency, cooling system and etc. all will affect the product temperature. Please verify the actual product temperature in the final application.

Part Number	Inductance	Tolerance	Test Frequency	RDC(m Ω)	Isat(A)	Irms(A)
	(μ H)	(\pm %)	(KHz)	Max(Typical)	Typical(Max)	Typical(Max)
JSHC1040H-R22M-GT	0.22	20	100	1(0.9)	60.0(54)	35.0(31.5)
JSHC1040H-R33M-GT	0.33	20	100	1.4(1.26)	51.0(45.9)	27.0(24.3)
JSHC1040H-R47M-GT	0.47	20	100	1.8(1.62)	39.0(35.1)	26.0(23.4)
JSHC1040H-R68M-GT	0.68	20	100	3(2.7)	32.0(28.8)	23.0(20.7)
JSHC1040H-1R0M-GT	1.0	20	100	3.3(2.97)	29.0(26.1)	19.0(17.1)
JSHC1040H-1R5M-GT	1.5	20	100	3.6(3.24)	27.0(24.3)	21.0(18.9)
JSHC1040H-2R2M-GT	2.2	20	100	9(8.1)	25.0(22.5)	12.0(10.8)
JSHC1040H-3R3M-GT	3.3	20	100	13.5(12.15)	16.0(14.4)	10.0(9)
JSHC1040H-4R7M-GT	4.7	20	100	16.5(14.85)	19.0(17.1)	7.0(6.3)
JSHC1040H-5R6M-GT	5.6	20	100	25(22.5)	14.0(12.6)	8.0(7.2)
JSHC1040H-6R8M-GT	6.8	20	100	28(25.2)	13.0(11.7)	7.0(6.3)
JSHC1040H-8R2M-GT	8.2	20	100	30(27)	10.0(9)	6.0(5.4)
JSHC1040H-100M-GT	10	20	100	30(27)	8.5(7.65)	7.5(6.75)
JSHC1040H-220M-GT	22	20	100	66(59.4)	7.0(6.3)	5.0(4.5)
JSHC1040H-330M-GT	33	20	100	155(139.5)	4.5(4.05)	3.0(2.7)
JSHC1040H-680M-GT	68	20	100	205(184.5)	3.5(3.15)	2.0(1.8)

Note: When ordering, please specify tolerance code. Tolerance: M=±20%

- All data is tested on 25°C ambient temperature.
- Inductance is tested at 100kHz, 1.0V.
- Heat rating current: The value of DC current when product temperature rise is $\Delta T40^{\circ}\text{C}$ ($T_a=25^{\circ}\text{C}$).
- Saturation current: The value of DC current when the inductance decreases approximately 30% of its.

Special remind: Circuit design, component placement, frequency, cooling system and etc. all will affect the product temperature. Please verify the actual product temperature in the final application.

Part Number	Inductance	Tolerance	Test Frequency	RDC(m Ω)	Isat(A)	Irms(A)
	(μ H)	(\pm %)	(KHz)	Max(Typical)	Typical(Max)	Typical(Max)
JSHC1040H-150M-GH	15	20	100	48()	7.0(6.3)	4.0(3.6)
JSHC1040H-470M-GH	47	20	100	145()	4.0(3.6)	3.0(2.7)
JSHC1040H-101M-GH	100	20	100	300()	3.0(2.7)	1.0(0.9)

Note: When ordering, please specify tolerance code. Tolerance: M=±20%

- All data is tested on 25°C ambient temperature.
- Inductance is tested at 100kHz, 1.0V.
- Heat rating current: The value of DC current when product temperature rise is $\Delta T40^{\circ}\text{C}$ ($T_a=25^{\circ}\text{C}$).
- Saturation current: The value of DC current when the inductance decreases approximately 30% of its.

Special remind: Circuit design, component placement, frequency, cooling system and etc.
all will affect the product temperature. Please verify the actual product temperature in the final application.

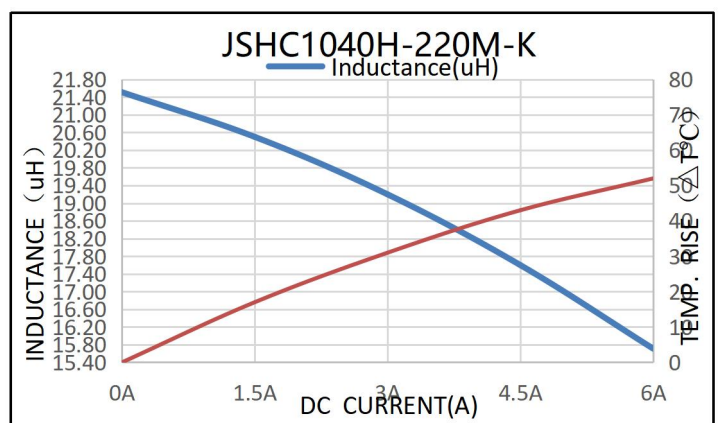
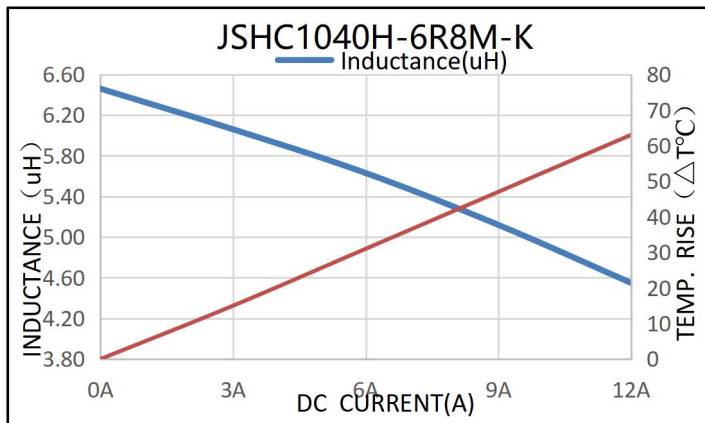
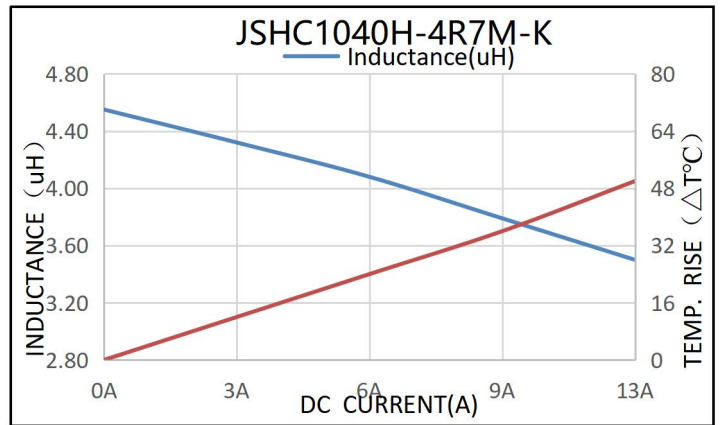
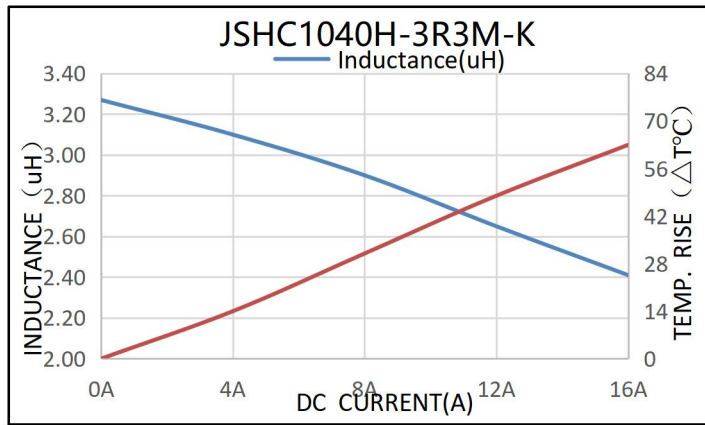
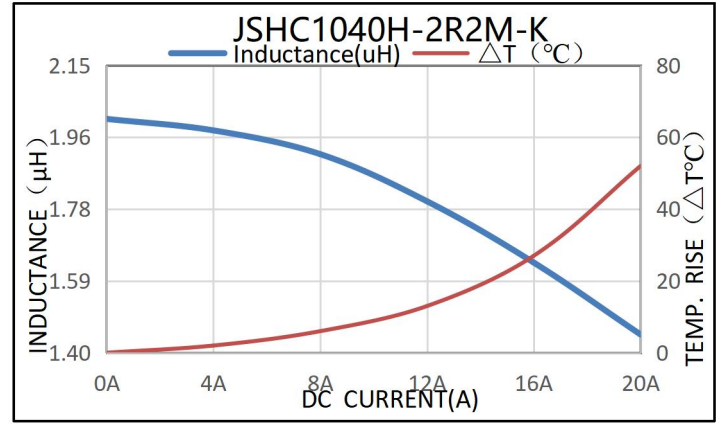
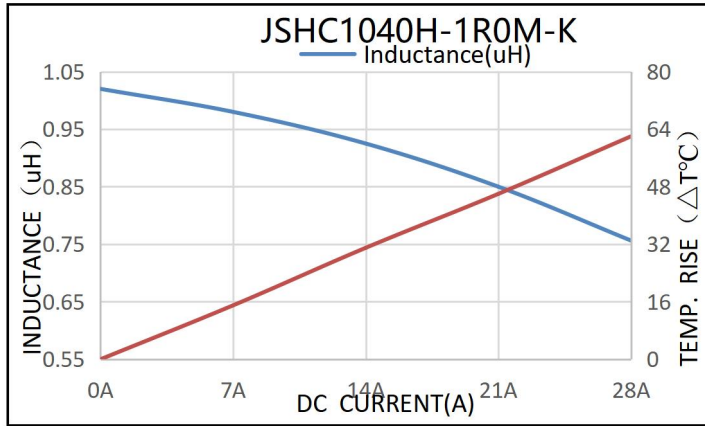
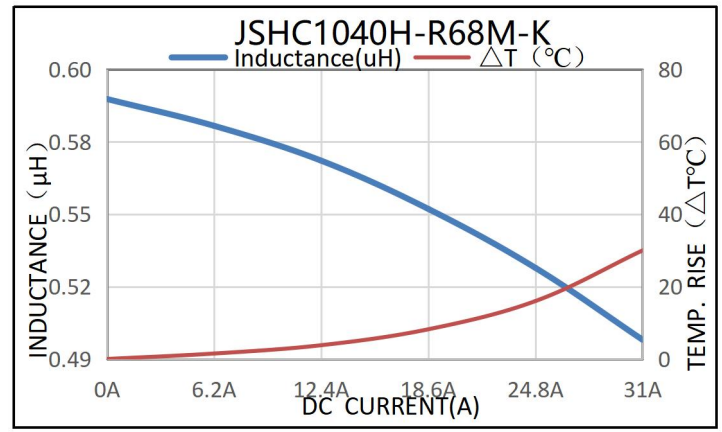
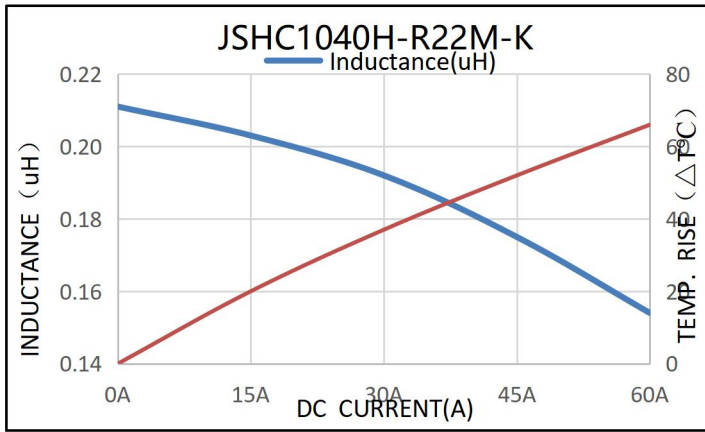

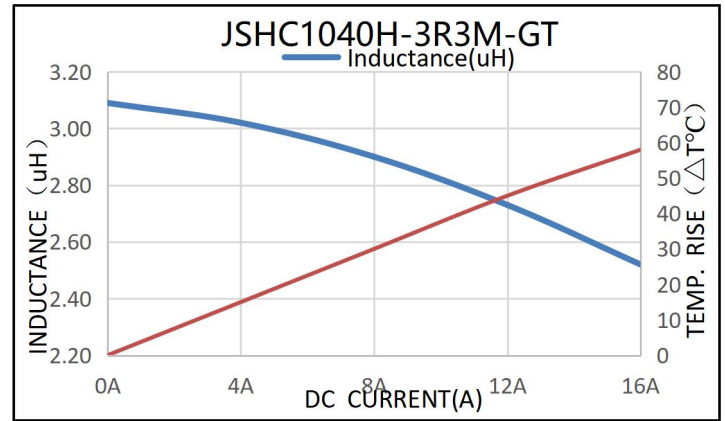
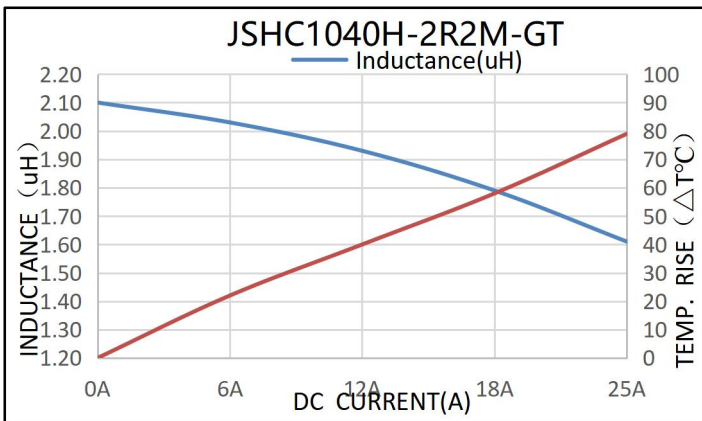
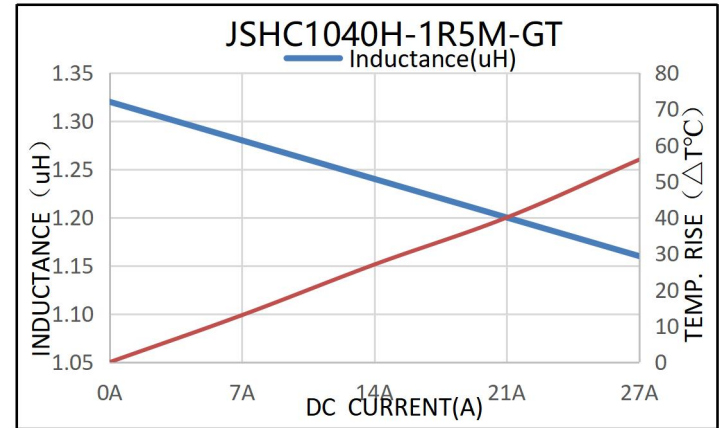
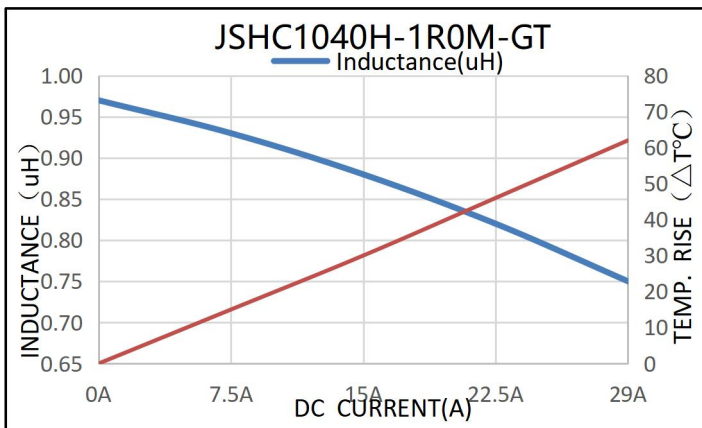
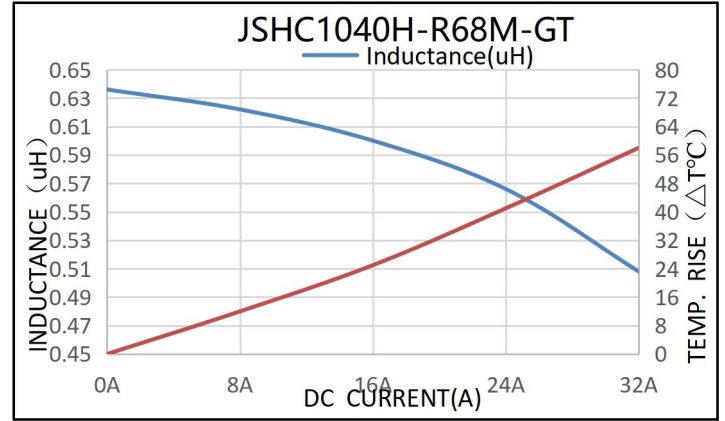
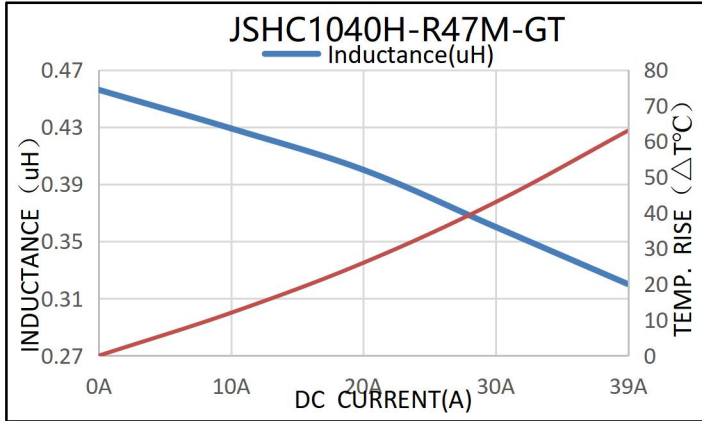
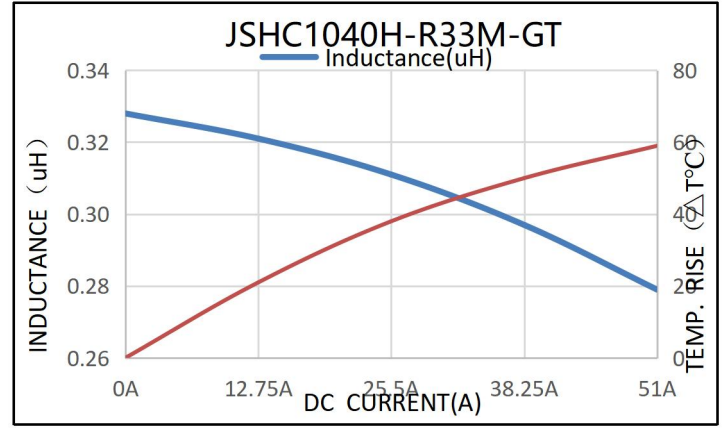
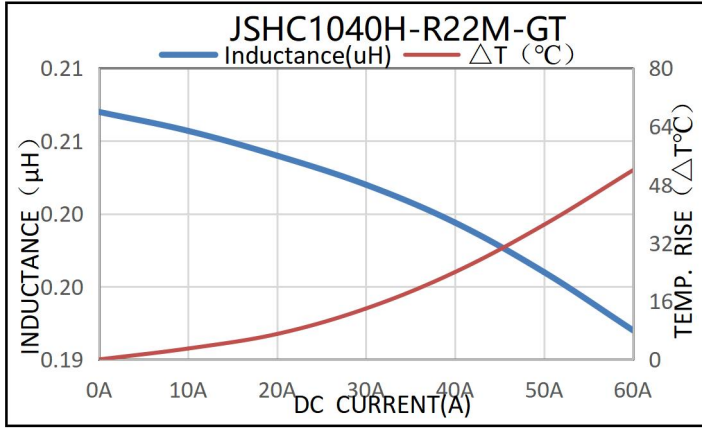

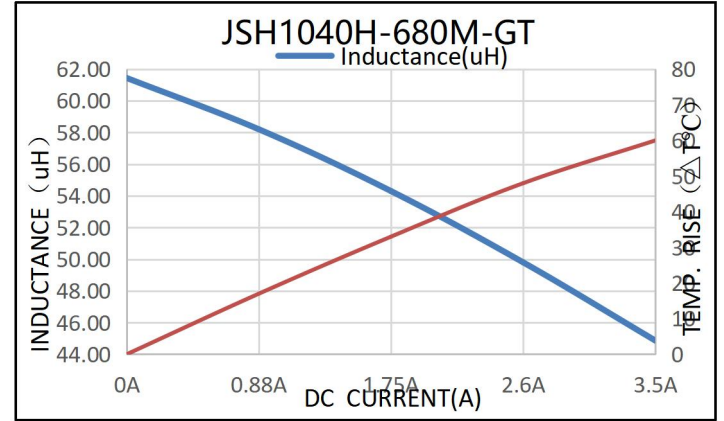
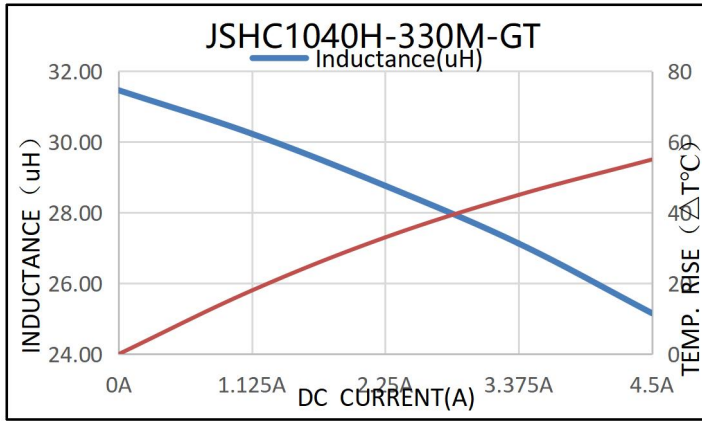
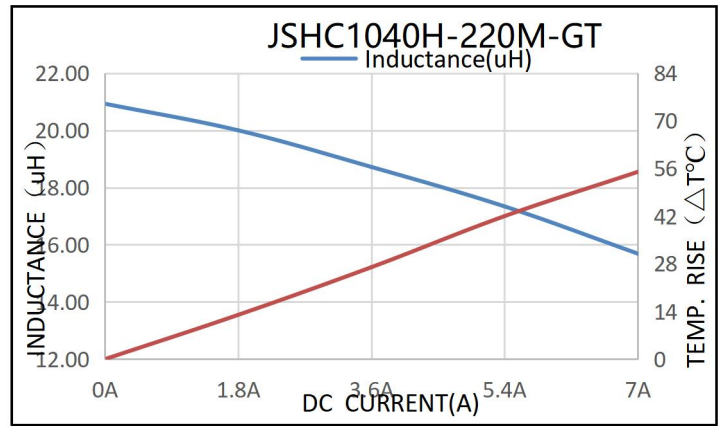
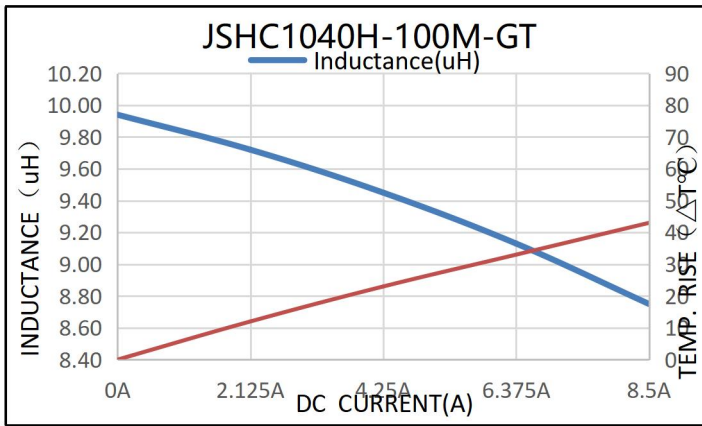
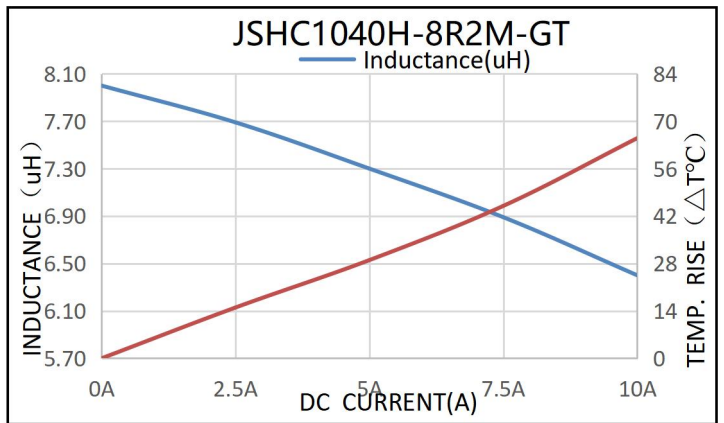
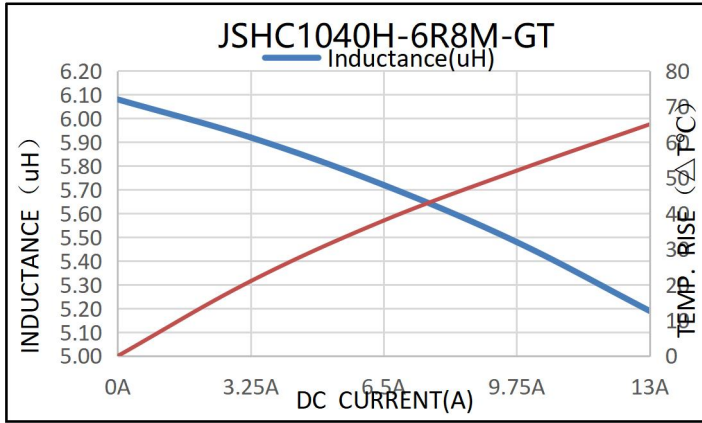
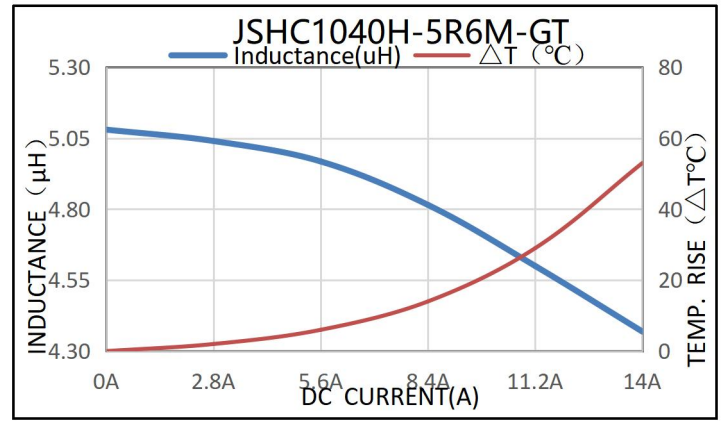
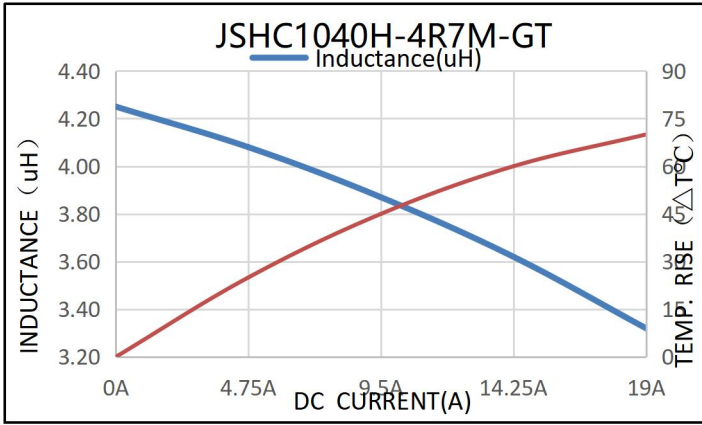

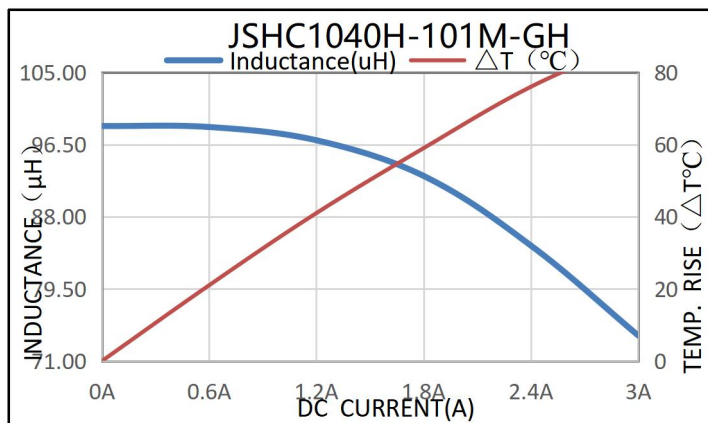
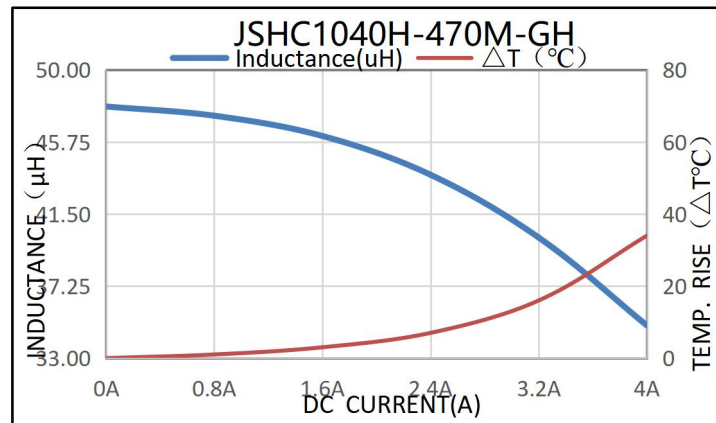
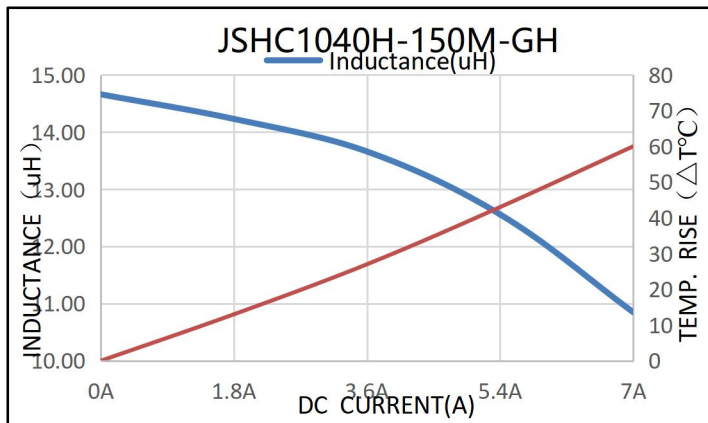

重庆金籁科技股份有限公司

Packaging Specifications

Carrier tape dimensions

A0	10.6±0.2
B0	12.0±0.2
K0	4.3±0.15
W	24.0±0.3
P	16.0±0.1
F	11.5±0.1
T	0.40±0.05
D0	1.5±0.10

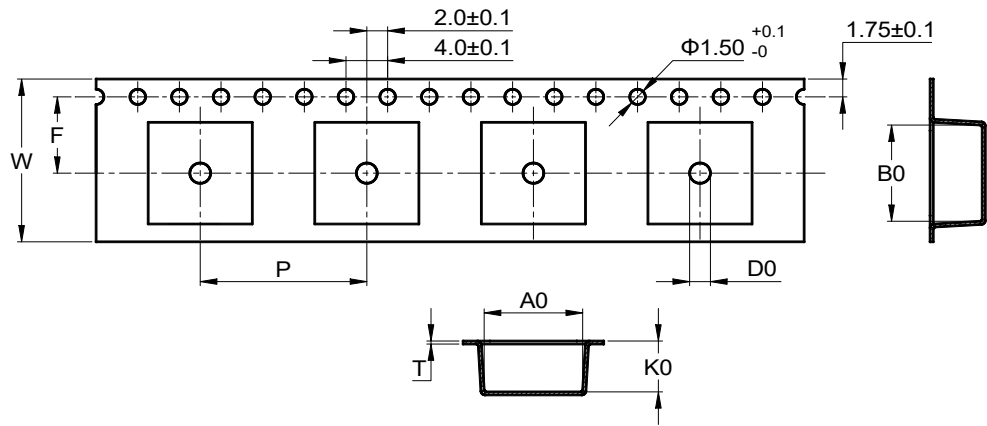

※ 包装参照国际标准 IEC 60286-3。

Packaging is referred to the international standard IEC 60286-3.

Packaging direction

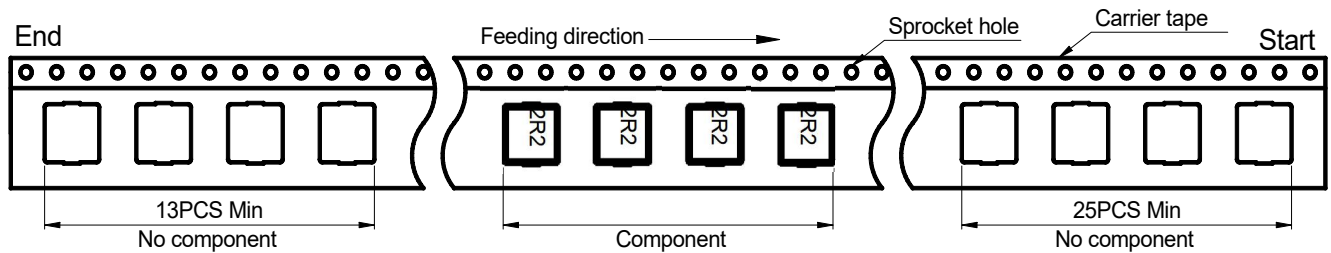

Reel dimensions

A	330 ± 2.0
B	100 Min
C	28.0Max
D	14.5 Min

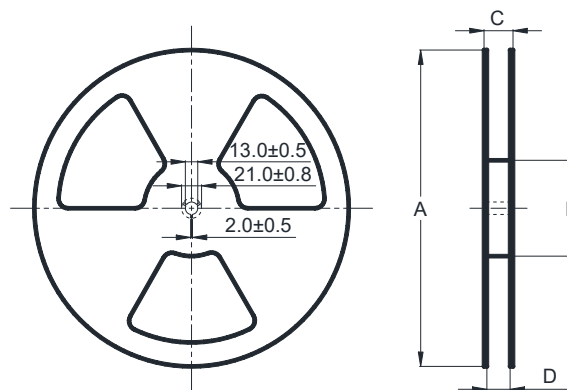

Cover tape peel-off condition

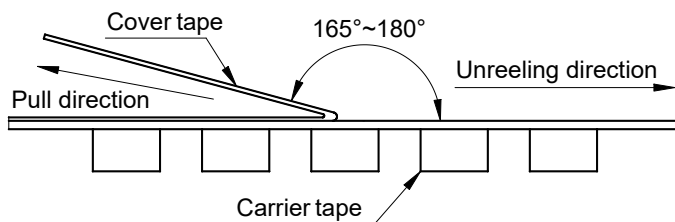
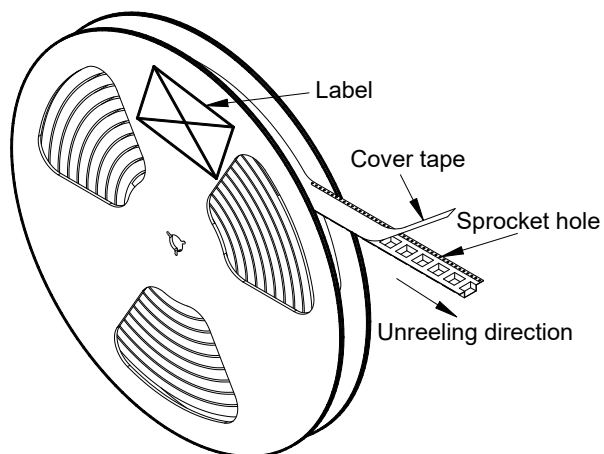

※ 盖带剥离力度为 0.1~1.3N。

Cover tape peel-off force will be 0.1 to 1.3N.

※ 参考剥离速度 300±10mm/分钟。

Reference peel-off speed 300±10mm/min.

Carton dimensions and packaging quantity

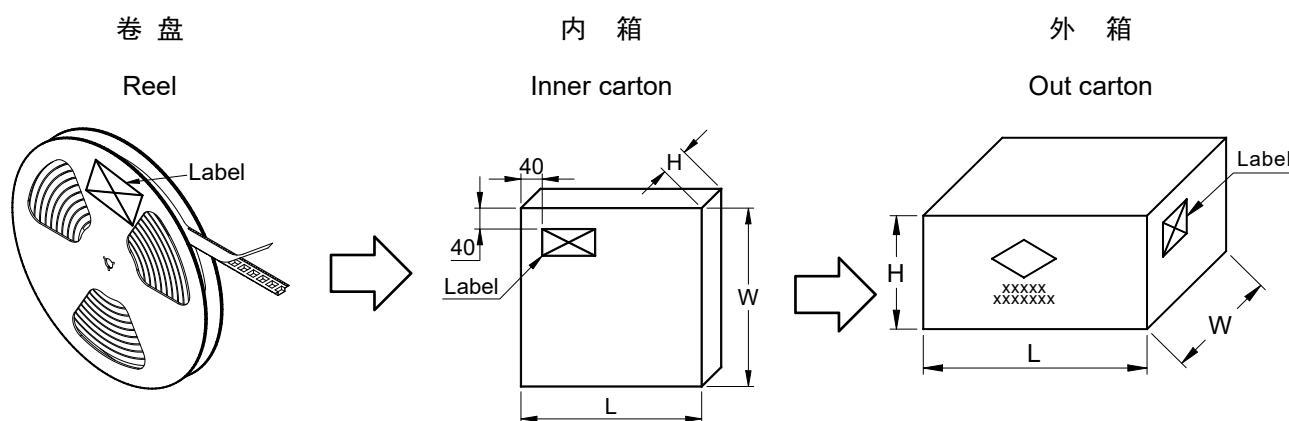

■ 内包装箱 (L×W×H)：340×340×66mm
Inner Carton

■ 外包装箱 (L×W×H)：360×360×215mm
Out Carton

SHC1040	每盘 包装数量 Per Reel Quatity	内箱 包装数量 Inner Carton Quatity	外箱 包装数量 Out Carton Quatity
	1,000 pcs	(1,000×2) = 2,000 pcs	(2,000×3) = 6,000 pcs