



产品承认书

Specification for Approval

客户 : _____
Customer : _____
客户料号 : _____
Customer P/N : _____
物料名称 : **一体成型电感**
Item Name : **Molding Power Choke**
金籁料号 : **MPS252010C 系列**
Jinlai P/N : _____
承认书编号 : **JL-APR-MOD-3787**
Spec No. : _____
版本号 : **A0**
Version No. : _____

制造商 Manufacture	
拟制 Prepared	谢奕君
审核 Checked	陈洁新
批准 Approved	村上
签章 Signature	
日期 Date	2023-03-09

客户承认 Approved by Customer	
确认 Confirmed	
审核 Checked	
批准 Approved	
签章 Signature	
日期 Date	

备注:
Remark

- 在使用产品前, 用户必须确认此产品是否适用于自身设计, 金籁仅保证产品符合此份承认书的规格。
Before use, customer should confirm whether this product is suitable for their design, JinLai only ensure products meet this specification.
- 本承认书的数据更改, 必须经双方确认, 任何一方单独修改无效。
This specification data change must be confirmed by both parties, any individual modification is invalid.
- 如客户未回签承认书即下订单, 则视为承认此份承认书。
If customer placed orders without signing back this specification, it is regarded as recognition.

重庆金籁科技股份有限公司
ChongQing JinLai Technology Corp.,

重庆市丰都县水天坪工业园区
Shuitianping industrial park, fengdu county, chongqing
Tel: (023)64599888 Fax:(023)81850171

Power Inductor MPS252010C

1. 特征 / Features

- 采用金属磁性材料具有高磁通饱和密度特性
High magnetic flux saturation density characteristics by metal magnetic material.
- 采用扁平线材实现较低Rdc
Low DC resistance by flat wire and achieve high conversion efficiency and lower temperature rising.
- 通过闭磁路结构减少漏磁通
Magnetically shielded structure to accomplish high resolution in EMC protection.
- Chip形状, 贴装稳定性强
High mounting stability due to Chip shape.
- 具有独立结构, 可靠性高
High reliability by original structure.
- 无卤素、无铅化, 符合RoHS要求
Halogen free, Lead free, RoHS Compliance.

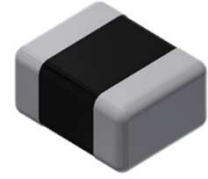

2. 应用 / Application

- DC/DC converter
- Smart phone/PAD, HDD/SSD, DVC/DSC
- mobile display panels, portable game devices, compact power supply modules, other.

3. 型号一览 / Part Number Construction

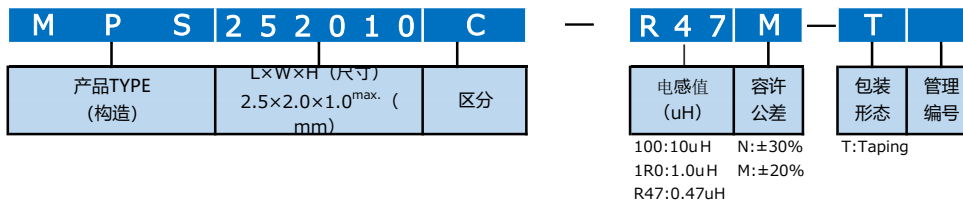

4. 特性规格表 / Characteristics Specification Table

客户料号 Customer's Part No.	品名 Part No.	L (uH)	公差范围 Tolerance	直流电阻Rdc (mΩ) Max.[Typ.]	饱和电流 I _{sat} (A) Max.[Typ.]	温升电流 I _{temp} (A) Max.[Typ.]	备注 Remarks
	MPS252010C-R24M-T	0.24	±20%	32 [25]	4.6 [5.8]	3.8 [4.5]	
	MPS252010C-R47M-T	0.47	±20%	46 [35]	3.5 [4.4]	3.1 [3.6]	
	MPS252010C-R68M-T	0.68	±20%	55 [42]	3.0 [3.9]	2.9 [3.3]	
	MPS252010C-1R0M-T	1.0	±20%	78 [60]	2.7 [3.4]	2.5 [3.0]	
	MPS252010C-1R5M-T	1.5	±20%	108 [90]	2.1 [2.7]	1.9 [2.3]	
	MPS252010C-2R2M-T	2.2	±20%	156 [130]	1.9 [2.4]	1.5 [1.8]	
	MPS252010C-3R3M-T	3.3	±20%	228 [195]	1.5 [1.9]	1.2 [1.4]	
	MPS252010C-4R7M-T	4.7	±20%	300 [250]	1.3 [1.6]	1.0 [1.2]	
	MPS252010C-6R8M-T	6.8	±20%	516 [415]	1.1 [1.4]	0.76 [0.9]	

·L测定频率: 1MHz, OSC LEVEL: 0.5V / Test frequency at 1MHz, OSC LEVEL: 0.5V

·L测定器: 4285A (Keysight Technologies) 或同等测定器

Inductance is measured with Keysight Technologies LCR meter 4285A. Equivalent measurement equipment may be used.

·额定电流: 以Isat和Itemp两个中的一个较小值作为额定电流值 / Rated current: smaller value of either Isat or Itemp.

·Isat: 电感量比初始值下降约30%时所加载的直流电流值

Isat: The DC current at which the inductance decreases approximately 30% from the actual initial value.

·Ittemp: 基于温度上升的情况(自身发热温度上升40°C)/Ittemp: When based on the temperature increase (temperature increase of 40°C by self heating).

※Ittemp是基于本公司的使用环境的参考值 / Ittemp is a reference value according to our usage environment.

※在最终应用中, 必须在产品温度上升不超过40°C的条件下进行电路设计

In the end application, the circuit design should be such that the part temperature rise does not exceed 40 °C.

·最大电压: 20[V] / Withstand DC Voltage: 20[V]



Power Inductor MPS252010C

5. L频率特性 / L Frequency Characteristics

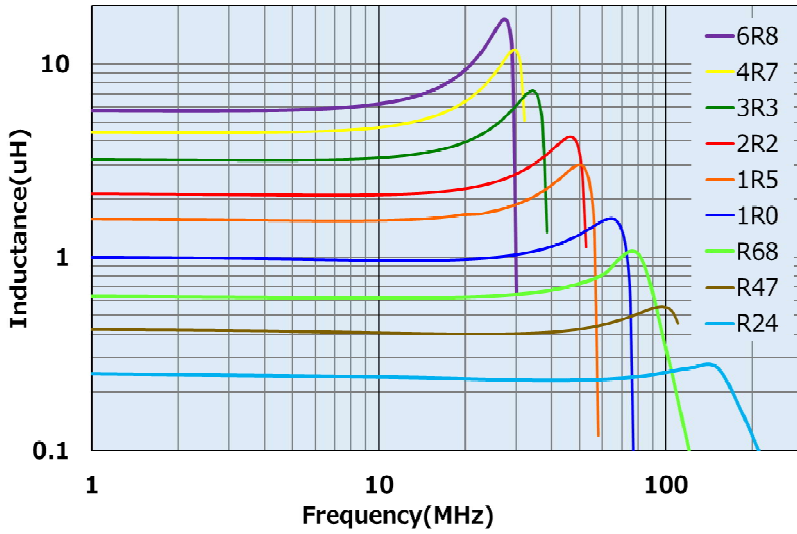

测定器: 4294A (Keysight Technologies)
或同等测定器

6. L直流叠加特性 / Inductance vs. DC Bias Characteristics

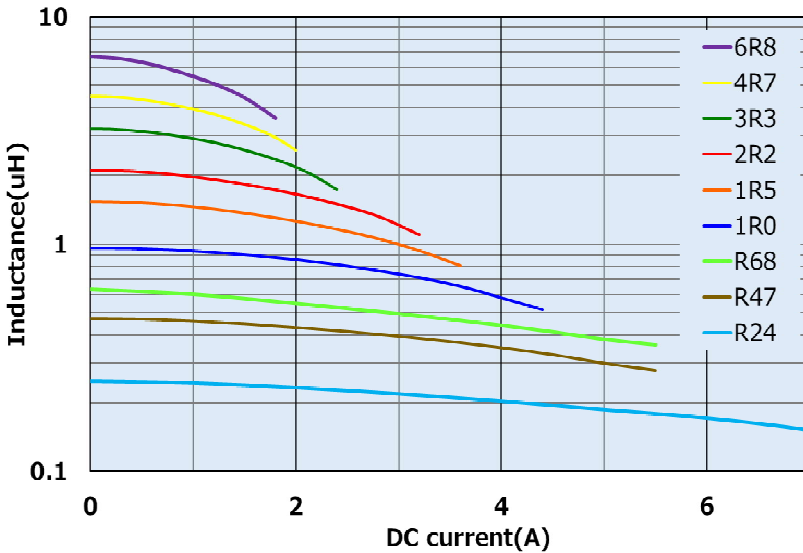

测定器: 4285A + 42841A + 42842C
(Keysight Technologies)
或同等测定器

7. 形状 / Shape & Dimensions

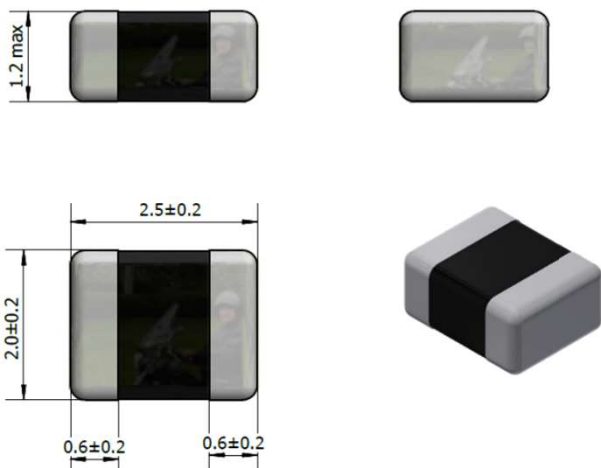

尺寸单位: mm
Dimensions in : mm

Power Inductor MPS252010C

8. 包装形态 / Packaging Style

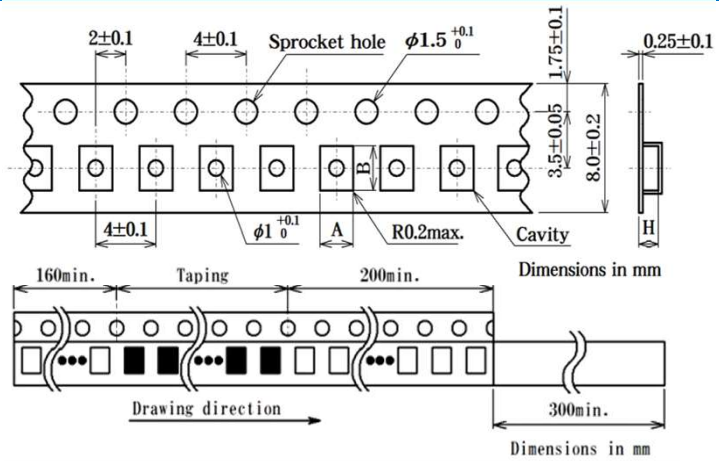
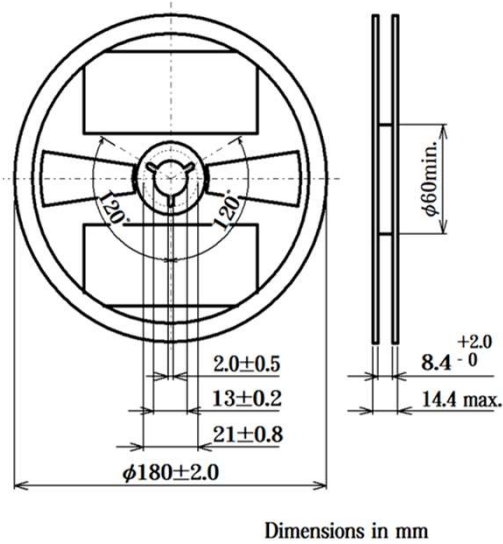

系列 Series	A	B	H	个数 (pcs/reel)	总重量 (g/reel)
MPS252010C-□□□-T	2.3 ± 0.1	2.8 ± 0.1	1.3 ± 0.1	3,000	140 ± 10

※A & B MEASUREMENT POINT TO BE 0.20mm FROM BOTTOM POCKET.

包装箱/Packing Box

品名 /Box Name	外形尺寸/Size(cm)	重量/Weight(g)
120 K 内箱/120K Inner Packing Box	39*29*21.5	433±20
120 K 外箱/120K Outer Packing Box	41*31*24.5	503±20
60 K 内箱/60K Inner Packing Box	29*20*21.5	229±20
60 K 外箱/60K Outer Packing Box	31*22*24.5	299±20
15K 包装箱/15K Packing Box	19.8*18.8*7	76±20

9. 推荐使用的焊盘图案 / Recommended Land Pattern

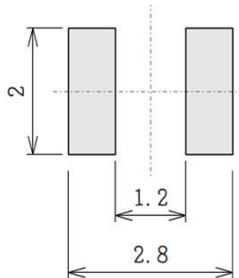

10. 推荐使用的回流焊曲线 / Recommended Reflow Profile

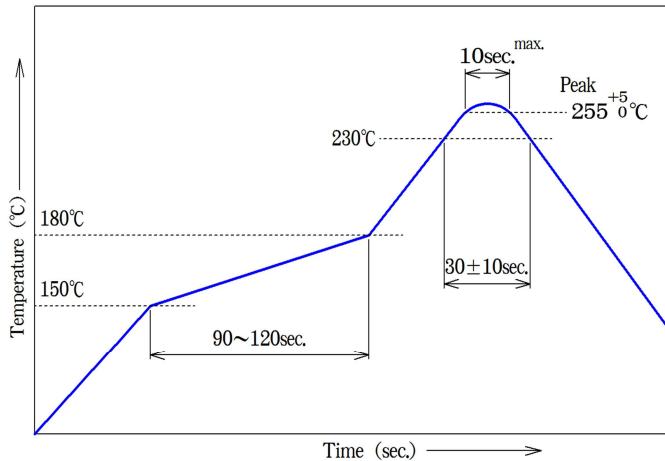

Power Inductor MPS252010C

11. 可靠性试验 / Reliability and Test Condition

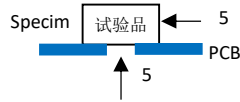
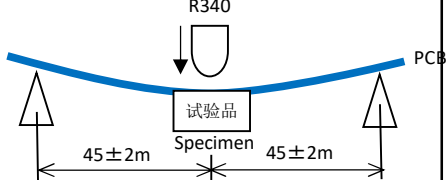
试验项目/Test item	试验条件/Test condition	规格/Specification
固着强度 Adhesive Test	<ul style="list-style-type: none"> · 负荷时间: 10±1秒 / Test time:10±1sec. · 移除负荷后进行测量。 Measure after removing pressure. 	<ul style="list-style-type: none"> · L变化率: ±10%以内/ ΔL/L: within ± 10% (以初期L为基准) (Change from an initial value) · 试验后的外观无异常 No abnormal appearance after the test.
基板弯曲试验 Bending test	<ul style="list-style-type: none"> · 弯曲量: 2mm / Bent depth: 2mm · 基板size: 40×100mm / PCB size:40×100mm · 基板厚度: 1.0mm / PCB thickness:1.0mm · 保持时间: 30秒 / Test time:30sec. 	<ul style="list-style-type: none"> · L变化率: ±10%以内/ ΔL/L: within ± 10% (以初期L为基准) (Change from an initial value) · 试验后的外观无异常 No abnormal appearance after the test.
耐振动性 Vibration test	<ul style="list-style-type: none"> · 扫描频率: 10~55~10Hz/分 Sweep frequency: 10~55Hz(10Hz to 55Hz to 10Hz in a period of one minute) · 全振宽度: 1.5mm / Amplitud: 1.5mm · X,Y,Z方向各2Hr (共6Hr) 2Hr in each of 3(X, Y, Z) axes. 	<ul style="list-style-type: none"> · L变化率: ±10%以内/ ΔL/L: within ± 10% (以初期L为基准) (Change from an initial value) · 试验后的外观无异常 No abnormal appearance after the test.
耐冲击性 Mechanical shock test	<ul style="list-style-type: none"> · 加速度: 1962m/s² Peak acceleration: 1962m/s² · 作用时间: 6ms / Duration of pulse: 6ms · X,Y,Z方向各3次 (共9次) 3 times in each of 3(X, Y, Z) axes. 	<ul style="list-style-type: none"> · L变化率: ±10%以内/ ΔL/L: within ± 10% (以初期L为基准) (Change from an initial value) · 试验后的外观无异常 No abnormal appearance after the test.
跌落试验 Drop test	<ul style="list-style-type: none"> · 将封装有试验品的基板安装在重量为500g的器具上, 从1m高处向相互垂直的3个方向自然落下在坚硬的木板上, 各3次 (共9次)。 The specimen must be fixed on PCB. It must be equipped with instruments of which weight is 500g. Then it shall be fallen freely from 100cm height to rigid wood 3 times in each of three axes. 	<ul style="list-style-type: none"> · L变化率: ±10%以内/ ΔL/L: within ± 10% (以初期L为基准) (Change from an initial value) · 试验后的外观无异常 No abnormal appearance after the test.
耐焊锡热 Resistance to Solder Heat	<ul style="list-style-type: none"> · Reflow焊锡/Reflow soldering method Preheat: 150~180°C 90±30sec. Peak temp.: 255(+5/-0)°C (230°Cmin.,30±10sec.) · 基板厚度: 1.0mm / PCB thickness:1.0mm · 2回 / 2times 	<ul style="list-style-type: none"> · L变化率: ±10%以内/ ΔL/L: within ± 10% (以初期L为基准) (Change from an initial value) · 试验后的外观无异常 No abnormal appearance after the test.
可焊性 Solder ability	<ul style="list-style-type: none"> · 电极在室温下涂上焊剂后根据下述条件将试验样品整体浸于焊锡槽中。 Electrode shall be immersed in flux at room temperature and then shall be immersed in solder bath after preheat. · 焊锡温度: 245±5°C、浸锡时间: 3±0.5sec. Solder temp:245±5°C、Dip time:3±0.5sec. 	<ul style="list-style-type: none"> · 电极面 90%以上覆盖新的焊料。 New solder shall cover 90% minimum of the surface immersed.
温度特性 Temperature drift	<ul style="list-style-type: none"> · 温度范围: -40~+125°C To be measured in the range of -40°C to 125°C. 	<ul style="list-style-type: none"> · Inductance温度系数: 1000ppm/°C以下 Inductance temperature coefficient 1000ppm/°C or less.



Power Inductor MPS252010C

试验项目/Test item	试验条件/Test condition	规格/Specification															
耐寒试验 Low temperature test	· 温度: $-40\pm 3^{\circ}\text{C}$ / Temp.: $-40\pm 3^{\circ}\text{C}$ · 放置时间: $500\pm 12\text{Hr}$ / Load: $500\pm 12\text{Hr}$	· L变化率: $\pm 10\%$ 以内/ $\Delta L/L$: within $\pm 10\%$ (以初期L为基准) (Change from an initial value) · 试验后的外观无异常 No abnormal appearance after the test.															
耐热试验 Dry heat test	· 温度: $+85\pm 2^{\circ}\text{C}$ / Temp.: $+85\pm 2^{\circ}\text{C}$ · 放置时间: $500\pm 12\text{Hr}$ / Load: $500\pm 12\text{Hr}$	· L变化率: $\pm 10\%$ 以内/ $\Delta L/L$: within $\pm 10\%$ (以初期L为基准) (Change from an initial value) · 试验后的外观无异常 No abnormal appearance after the test.															
耐湿试验 Humidity test	· 温度: $+40\pm 2^{\circ}\text{C}$ / Temp.: $+40\pm 2^{\circ}\text{C}$ · 湿度: $90\sim 95\%\text{RH}$ / Humidity: $90\sim 95\%$ · 放置时间: $500\pm 12\text{Hr}$ / Load: $500\pm 12\text{Hr}$	· L变化率: $\pm 10\%$ 以内/ $\Delta L/L$: within $\pm 10\%$ (以初期L为基准) (Change from an initial value) · 试验后的外观无异常 No abnormal appearance after the test.															
热冲击试验 Thermal shock test	· 1循环条件 / Condition of 1 cycle <table border="1" style="margin-left: auto; margin-right: auto;"> <thead> <tr> <th>Step</th> <th>温度 ($^{\circ}\text{C}$) Temp.</th> <th>时间 (min.) Duration</th> </tr> </thead> <tbody> <tr> <td>1</td> <td>-40 ± 3</td> <td>30 ± 3</td> </tr> <tr> <td>2</td> <td>常温 Room temp.</td> <td>3以下 Within 3</td> </tr> <tr> <td>3</td> <td>$+125\pm 2$</td> <td>30 ± 3</td> </tr> <tr> <td>4</td> <td>常温 Room temp.</td> <td>3以下 Within 3</td> </tr> </tbody> </table> · 放置时间: $100\pm 12\text{cycle}/\text{Load}: 100\pm 12\text{cycle}$	Step	温度 ($^{\circ}\text{C}$) Temp.	时间 (min.) Duration	1	-40 ± 3	30 ± 3	2	常温 Room temp.	3以下 Within 3	3	$+125\pm 2$	30 ± 3	4	常温 Room temp.	3以下 Within 3	· L变化率: $\pm 10\%$ 以内/ $\Delta L/L$: within $\pm 10\%$ (以初期L为基准) (Change from an initial value) · 试验后的外观无异常 No abnormal appearance after the test.
Step	温度 ($^{\circ}\text{C}$) Temp.	时间 (min.) Duration															
1	-40 ± 3	30 ± 3															
2	常温 Room temp.	3以下 Within 3															
3	$+125\pm 2$	30 ± 3															
4	常温 Room temp.	3以下 Within 3															

12. 温度范围 / Temperature Range

· 使用温度范围: $-40\sim +125^{\circ}\text{C}$ / Operating Temperature range: -40°C to $+125^{\circ}\text{C}$

※使用温度范围包括自我温度上升 / ※Operating temperature range includes self-temperature rise.

※部件温度 (周围温度 + 温度上升) 在最恶劣的操作条件下, 不得超过 125°C 。

电路设计、组件布局、PCB迹线尺寸/厚度、气流和其他冷却条件都会影响部件温度。

部件温度必须在最终应用中验证。

The part temperature (ambient + temp rise) should not exceed 125°C under worst case operating conditions.

Circuit design, component placement, PCB trace size and thickness, airflow and other cooling provisions all affect the part temperature. Part temperature should be verified in the end application.

· 保管温度范围: $+5\sim +40^{\circ}\text{C}$ (Taping) / Taping Package Storage Temperature range: $+5^{\circ}\text{C}$ to $+40^{\circ}$

Power Inductor MPS252010C

13. 使用上的注意事项 / Reminders

- 请在交货规格书的规定内使用。
Do not use for a purpose outside of the contents regulated in the delivery specifications.
- 额定电流
 - 请勿超过额定电流使用。
Do not exceed the rated current.
 - ※超过额定电流使用时，可能导致绝缘电阻降低、过度发热。
If it is used exceeding the rated current, insulation resistance may decrease and excessive heat generation may occur.
 - ※万一本公司产品发生异常或不良情况，请务必在成品上添加适当的故障安全功能以防止二次灾害。
In case of any abnormality or malfunction of our products, be sure to add the appropriate Fail safe function to the finished product to prevent secondary disasters.
- 保管方法
 - 保管期限：6个月以内 · 环境：温度5~40°C、湿度20~75%RH
The storage period is less than 6 months. Be sure to follow the storage conditions (temperature: 5 to 40°C, humidity: 20 to 75% RH or less).
 - ※超过保管期限时，端子电极的焊接性可能会劣化。
If the storage period elapses, the soldering of the terminal electrodes may deteriorate.
 - ※请避免在日光直射和发生振动等地方保管。
Avoid storage in places subject to direct sunlight, vibration, etc.
 - ※请勿在受气体腐蚀影响的环境中（氯气、酸、碱、硫化气体等）使用、保管。
Do not use or store in an environment (chlorine gas, acid, alkali, sulfide gas, etc.) that is affected by gas corrosion.
- 搬运
 - 请勿施加过度的振动、冲击。
Please do not give excessive vibration and impact.
- 电路板贴装
 - 请勿在线圈下方设计通孔或图案。
Do not design Through hole or Pattern under Coil.
 - 请在避免线圈间互相接触的条件下进行布局设计。
Please arrange so that Coil does not touch each other.
 - 当将电路板集成到SET中时，由于螺丝紧固件等会造成电路板变形，请不要施加应力到线圈上。
When incorporating the circuit board into the SET, be sure not to apply stress to the Coil due to distortion of the board due to Screw fastening part or
 - 请考虑线圈自身发热的热设计。
Self heating (temperature increase) occurs when the power is turned ON, so the tolerance should be sufficient for the set thermal design.
- 焊接修正方法
Soldering correction method
 - Pre Heat: 150°C 1分 · 烙铁头温度：350°C以下 · 焊接修正作业时间：3秒以内
Pre Heat: 150°C 1min. Soldering tip temperature: 350 ° C or less Correction work time: within 3 seconds
 - 烙铁功率：80W以下 · 烙铁头直径：Φ3mm以下
Soldering tip power: 80 W or less Soldering tip diameter: Φ 3 mm or less
- 请佩戴腕带消除体内静电（带电状态下请勿触摸线圈）。
Use a wrist band to discharge static electricity in your body through the grounding wire.
- 请勿靠近磁铁或带磁铁的物体。
Do not expose the products to magnets or magnetic fields.
- 对于树脂涂层，请注意树脂的选择，并在贴装状态下进行可靠性评估。
For resin Coating, pay attention to resin selection and perform reliability evaluation in the mounted state.
- 本目录所列产品以适用于一般民用电子设备（家电产品、通信设备、计算机设备等）为前提在正常操作和使用条件下使用。
- 对使用在要求非常高的安全性和可靠性的应用场合或者因设备故障、误操作可能对人体生命和社会造成巨大影响的应用场合（参照下列）不作保
The products listed on this catalog are intended for use in general electronic equipment (home appliances, telecommunications equipment, computer equipment) under a normal operation and use condition. The products are not designed or warranted to meet the requirements of the applications listed below, whose performance and/or quality require a more stringent level of safety or reliability, or whose failure, malfunction or trouble could cause serious damage to society, person or property.
 - 航空/宇宙设备 · 军事用设备 · 情报处理设备（公共性高的）
 - 医疗设备 · 安全装置 · 公共运输设备（汽车、电车、船舶等）
 - 发电控制设备 · 海底作业用设备 · 防灾/防犯機器
 - 原子能相关设备 · 交通机关控制设备 · 非通用用途的其它用途
 - Aerospace/aviation equipment · Military equipment · Public information-processing equipment
 - Medical equipment · Safety equipment · Transportation equipment (cars, electric trains, ships, etc.)
 - Power-generation control equipment · Seabed equipment · Disaster prevention/crime prevention equipment
 - Atomic energy-related equipment · Transportation control equipment · Other applications that are not considered general-purpose applications